

©2006 KEMET Corporation

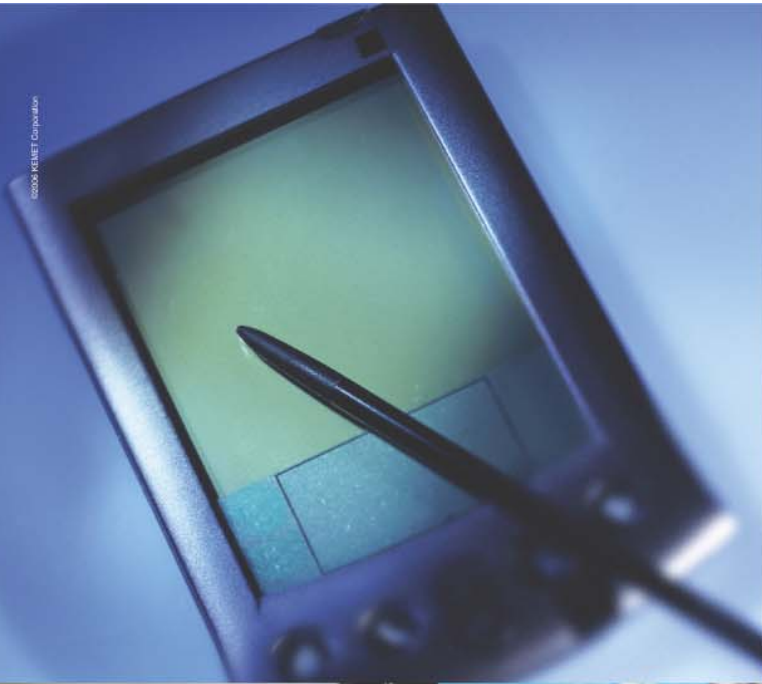

# Surface Mount Ferrite Products

[www.kemet.com](http://www.kemet.com)

F3115C 5/07

**KEMET**  
CHARGED.™





## Table of Contents

<b>Wire Wound Chip Inductors - LB Series</b> .....	<b>Page 4</b>
0603 Case Size Standard Type (LB 1608 Series) .....	Page 5
0805 Case Size Standard Type (LB 2012 Series) .....	Page 5
0806 Case Size Standard Type (LB 2016 Series) .....	Page 5
1007 Case Size Standard Type (LB 2518 Series) .....	Page 5
1207 Case Size Standard Type (LB 3218 Series) .....	Page 6
0603 Case Size Standard Type (LB MF 1608 Series) .....	Page 6
0805 Case Size High Current Type (LB C2012 Series) .....	Page 6
0806 Case Size High Current Type (LB C2016 Series) .....	Page 6
1007 Case Size High Current Type (LB C2518 Series) .....	Page 7
0805 Case Size Low RDC Type (LB R2012 Series) .....	Page 7
1007 Case Size Low RDC Type (LB R2518 Series) .....	Page 7
<b>Wire Wound Chip Inductors - CB Series</b> .....	<b>Page 8</b>
0805 Case Size Low RDC Type (CB 2012 Series) .....	Page 9
0806 Case Size Low RDC Type (CB 2016 Series) .....	Page 9
1007 Case Size Low RDC Type (CB 2518 Series) .....	Page 9
0805 Case Size High Current Type (CBC 2012 Series) .....	Page 9
0806 Case Size High Current Type (CBC 2016 Series) .....	Page 9
1007 Case Size High Current Type (CBC 2518 Series) .....	Page 10
1210 Case Size High Current Type (CBC 3225 Series) .....	Page 10
0805 Case Size Low Profile Type (CBL 2012 Series) .....	Page 10
0603 Case Size Power, Bottom Surface Electrode Type (CBMF 1608 Series) .....	Page 10
<b>Multilayer Chip Inductors for High Frequency - HK Series</b> .....	<b>Page 11</b>
0201 Case Size Multilayer Chip Inductors for High Frequency (HK 0603 Series) .....	Page 12
0402 Case Size Multilayer Chip Inductors for High Frequency (HK 1005 Series) .....	Page 13
0603 Case Size Multilayer Chip Inductors for High Frequency (HK 1608 Series) .....	Page 14
0805 Case Size Multilayer Chip Inductors for High Frequency (HK 2125 Series) .....	Page 15
<b>Multilayer Chip Inductors - LK/CK/CKP Series</b> .....	<b>Page 16</b>
0402 Case Size Multilayer Chip Inductors (LK 1005 Series) .....	Page 17
0603 Case Size Multilayer Chip Inductors (LK 1608 Series) .....	Page 18
0805 Case Size Multilayer Chip Inductors (LK 2125 Series) .....	Page 19
0603 Case Size Multilayer Chip Inductors (CK 1608 Series) .....	Page 20
0805 Case Size Multilayer Chip Inductors (CK 2125 Series) .....	Page 20
1206 Case Size Multilayer Chip Inductors (CKP 3216 Series) .....	Page 20
<b>Low Profile SMD Inductors (NR Series)</b> .....	<b>Page 21</b>
NR3010 Type (1.0mm Max. Height) .....	Page 21
NR4010 Type (1.0mm Max. Height) .....	Page 21
NR4012 Type (1.2mm Max. Height) .....	Page 22
NR4018 Type (1.8mm Max. Height) .....	Page 22
NR6012 Type (1.2mm Max. Height) .....	Page 22
NR8040 Type (4.2mm Max. Height) .....	Page 22
<b>High Current Ferrite Chip Beads - FB Series M Type</b> .....	<b>Page 23</b>
0603 Case Size High Current Ferrite Chip Beads (FB Series M Type) .....	Page 24
0805 Case Size High Current Ferrite Chip Beads (FB Series M Type) .....	Page 24
1206 Case Size High Current Ferrite Chip Beads (FB Series M Type) .....	Page 24
1806 Case Size High Current Ferrite Chip Beads (FB Series M Type) .....	Page 24
High Impedence Type Ferrite Chip Beads (FB Series M Type) .....	Page 25
<b>Multilayer Ferrite Chip Beads - BK Series</b> .....	<b>Page 26</b>
0201 Multilayer Ferrite Chip Beads Standard Type (BK Series) .....	Page 27
0402 Multilayer Ferrite Chip Beads Standard Type (BK Series) .....	Page 27
0402 Multilayer Ferrite Chip Beads for Power Lines (BKP Series) .....	Page 27
0603 Multilayer Ferrite Chip Beads Standard Type (BK Series) .....	Page 28
0603 Multilayer Ferrite Chip Beads for Power Lines (BKP Series) .....	Page 28
0805 Multilayer Ferrite Chip Beads Standard Type (BK Series) .....	Page 29
0805 Multilayer Ferrite Chip Beads for Power Lines (BKP Series) .....	Page 29

## Wire Wound Chip Inductors - LB Series

### Features:

- Small size wound chip inductor with low DC resistance
- Dimension without directional influence on mountability and characteristics
- Excellent Q and SRF (LB H1608 Series)

### Applications:

- Digital Still Cameras (DSC), Digital Video Cameras (DVC), PDA's and other portable digital equipment
- Portable telephones and wireless LAN (LB H1608 Series)

### Operating Temperature:

- -25°C to +105°C (including self-generated heat)

## Part Numbering Table

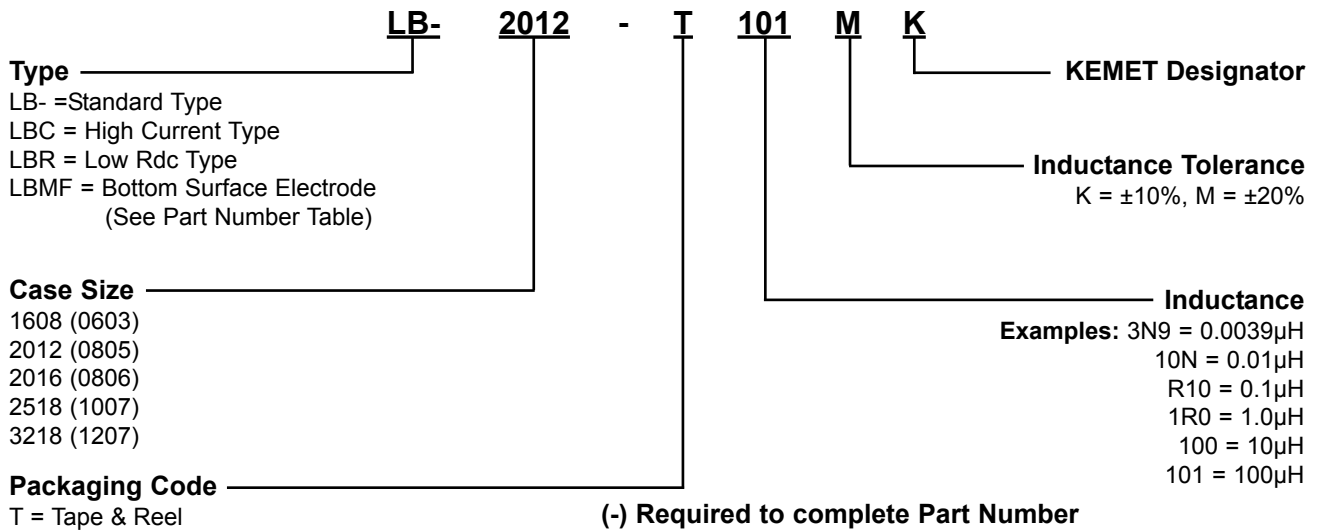

## Dimension Table in millimeters (inches)

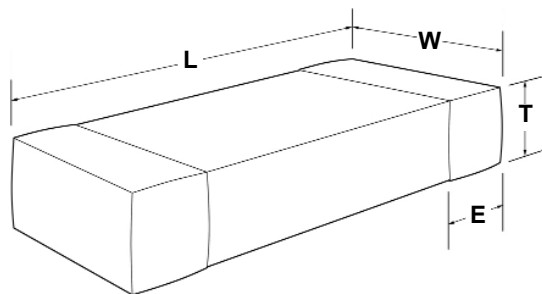

Dim. Code	EIA Case Size	L Length (inches)	W Width (inches)	T Thickness Maximum (inches)	E (inches)
1608	0603	1.6 ±0.1 (0.063 ±0.004)	0.8 ±0.1 (0.031 ±0.004)	0.8 ±0.1 (0.031 ±0.004)	0.35 ±0.2 (0.014 ±0.008)
2012	0805	2.0 ±0.2 (0.079 ±0.008)	1.25 ±0.2 (0.049 ±0.008)	1.25 ±0.2 (0.049 ±0.008)	0.5 ±0.2 (0.02 ±0.008)
2016	0806	2.0 ±0.2 (0.079 ±0.008)	1.6 ±0.2 (0.063 ±0.008)	1.6 ±0.2 (0.063 ±0.008)	0.5 ±0.2 (0.02 ±0.008)
2518	1007	2.5 ±0.2 (0.098 ±0.008)	1.8 ±0.2 (0.072 ±0.008)	1.8 ±0.2 (0.072 ±0.008)	0.5 ±0.2 (0.02 ±0.008)
3218	1207	3.2 ±0.2 (0.128 ±0.008)	1.8 ±0.2 (0.072 ±0.008)	1.8 ±0.2 (0.072 ±0.008)	0.6 ±0.2 (0.024 ±0.008)



### 0603 Case Size Standard Type (LB 1608 Series)

Ordering Code	Inductance (μH)	Inductance Tolerance	Minimum Self Resonant Frequency (MHz)	DC Resistance (Ω) (±30%)	Maximum Rated Current (mA)	Measuring Frequency (MHz)	Tape & Reel Packaging Quantity
LB-1608-T4R7MK	4.7	±20%	45	0.55	70	7.96	4,000
LB-1608-T8R2MK	8.2	±20%	32	0.70	50	2.52	4,000
LB-1608-T100MK	10	±20%	32	0.70	50	2.52	4,000

### 0805 Case Size Standard Type (LB 2012 Series)

Ordering Code	Inductance (μH)	Inductance Tolerance	Minimum Self Resonant Frequency (MHz)	DC Resistance (Ω) (±30%)	Maximum Rated Current (mA)	Measuring Frequency (MHz)	Tape & Reel Packaging Quantity
LB-2012-T1R0MK	1.0	±20%	100	0.15	300	7.96	3,000
LB-2012-T2R2MK	2.2	±20%	80	0.23	240	7.96	3,000
LB-2012-T4R7MK	4.7	±20%	45	0.40	140	7.96	3,000
LB-2012-T100MK	10	±20%	32	0.70	100	2.52	3,000
LB-2012T100MRK*	10	±20%	32	0.50	100	2.52	3,000
LB-2012-T220MK	22	±20%	15	1.70	75	2.52	3,000
LB-2012-T470MK	47	±20%	11	3.70	50	2.52	3,000
LB-2012-T101MK	100	±20%	8	7.00	30	0.796	3,000

\* Low Rdc Type

### 0806 Case Size Standard Type (LB 2016 Series)

Ordering Code	Inductance (μH)	Inductance Tolerance	Minimum Self Resonant Frequency (MHz)	DC Resistance (Ω) (±30%)	Maximum Rated Current (mA)	Measuring Frequency (MHz)	Tape & Reel Packaging Quantity
LB-2016-T1R0MK	1.0	±20%	100	0.09	455	7.96	2,000
LB-2016-T1R5MK	1.5	±20%	80	0.11	350	7.96	2,000
LB-2016-T2R2MK	2.2	±20%	70	0.13	315	7.96	2,000
LB-2016-T3R3MK	3.3	±20%	55	0.20	280	7.96	2,000
LB-2016-T4R7MK	4.7	±20%	45	0.25	210	7.96	2,000
LB-2016-T6R8MK	6.8	±20%	38	0.35	175	7.96	2,000
LB-2016-T100MK	10	±20%	32	0.50	155	2.52	2,000
LB-2016-T150MK	15	±20%	28	0.70	130	2.52	2,000
LB-2016-T220MK	22	±20%	16	1.00	105	2.52	2,000
LB-2016-T330MK	33	±20%	14	1.70	85	2.52	2,000
LB-2016-T470MK	47	±20%	11	2.40	60	2.52	2,000
LB-2016-T680MK	68	±20%	10	3.00	50	2.52	2,000
LB-2016-T101MK	100	±20%	8	4.50	40	0.796	2,000

### 1007 Case Size Standard Type (LB 2518 Series)

Ordering Code	Inductance (μH)	Inductance Tolerance	Minimum Self Resonant Frequency (MHz)	DC Resistance (Ω) (±30%)	Maximum Rated Current (mA)	Measuring Frequency (MHz)	Tape & Reel Packaging Quantity
LB-2518-T1R0MK	1.0	±20%	100	0.06	500	7.96	2,000
LB-2518-T1R5MK	1.5	±20%	80	0.07	400	7.96	2,000
LB-2518-T2R2MK	2.2	±20%	68	0.09	340	7.96	2,000
LB-2518-T3R3MK	3.3	±20%	54	0.11	270	7.96	2,000
LB-2518-T4R7MK	4.7	±20%	46	0.13	240	7.96	2,000
LB-2518-T6R8MK	6.8	±20%	38	0.15	195	7.96	2,000
LB-2518-T100MK	10	±20%	30	0.25	165	2.52	2,000
LB-2518-T150MK	15	±20%	23	0.32	145	2.52	2,000
LB-2518-T220MK	22	±20%	19	0.50	115	2.52	2,000
LB-2518-T330MK	33	±20%	15	0.70	95	2.52	2,000
LB-2518-T470MK	47	±20%	12	0.95	85	2.52	2,000
LB-2518-T680MK	68	±20%	9.5	1.50	70	2.52	2,000
LB-2518-T101MK	100	±20%	9	2.10	55	0.796	2,000
LB-2518-T151MK	150	±20%	7	3.20	45	0.796	2,000
LB-2518-T221MK	220	±20%	5.5	4.50	35	0.796	2,000
LB-2518-T331MK	330	±20%	4.5	7.00	30	0.796	2,000
LB-2518-T471MK	470	±20%	3.5	10.00	25	0.796	2,000
LB-2518-T681MK	680	±20%	3	17.00	20	0.796	2,000
LB-2518-T102MK	1000	±20%	2.4	24.00	15	0.252	2,000



### 1207 Case Size Standard Type (LB 3218 Series)

Ordering Code	Inductance (μH)	Inductance Tolerance	Minimum Self Resonant Frequency (MHz)	DC Resistance (Ω) (±30%)	Maximum Rated Current (mA)	Measuring Frequency (MHz)	Tape & Reel Packaging Quantity
LB-3218-T1R0MK	1.0	±20%	100	0.06	1075	7.96	2,000
LB-3218-T1R5MK	1.5	±20%	80	0.07	860	7.96	2,000
LB-3218-T2R2MK	2.2	±20%	68	0.09	775	7.96	2,000
LB-3218-T3R3MK	3.3	±20%	54	0.11	560	7.96	2,000
LB-3218-T4R7MK	4.7	±20%	41	0.13	550	7.96	2,000
LB-3218-T6R8MK	6.8	±20%	40	0.17	380	7.96	2,000
LB-3218-T100(_K)	10	K=10%, M=±20%	30	0.25	340	2.52	2,000
LB-3218-T150(_K)	15	K=10%, M=±20%	25	0.32	300	2.52	2,000
LB-3218-T220(_K)	22	K=10%, M=±20%	19	0.49	255	2.52	2,000
LB-3218-T330(_K)	33	K=10%, M=±20%	15	0.75	215	2.52	2,000
LB-3218-T470(_K)	47	K=10%, M=±20%	12	0.92	205	2.52	2,000
LB-3218-T680(_K)	68	K=10%, M=±20%	11	1.49	145	2.52	2,000
LB-3218-T101(_K)	100	K=10%, M=±20%	8	2.40	140	0.796	2,000
LB-3218-T151(_K)	150	K=10%, M=±20%	7	3.20	105	0.796	2,000
LB-3218-T221(_K)	220	K=10%, M=±20%	5	5.40	80	0.796	2,000
LB-3218-T331(_K)	330	K=10%, M=±20%	4	7.00	65	0.796	2,000
LB-3218-T471(_K)	470	K=10%, M=±20%	3.5	14.00	54	0.796	2,000
LB-3218-T681(_K)	680	K=10%, M=±20%	3	17.00	45	0.796	2,000
LB-3218-T102(_K)	1000	K=10%, M=±20%	2.4	27.00	39	0.252	2,000

(\_) - Insert Inductance Tolerance Code (K or M)

### 0603 Case Size Standard Type (LB MF 1608 Series)

Ordering Code	Inductance (μH)	Inductance Tolerance	Minimum Self Resonant Frequency (MHz)	DC Resistance (Ω) (±30%)	Maximum Rated Current (mA)	Measuring Frequency (MHz)	Tape & Reel Packaging Quantity
LBMF1608T1R0MK	1.0	±20%	100	0.19	620	7.96	3,000
LBMF1608T2R2MK	2.2	±20%	70	0.33	430	7.96	3,000
LBMF1608T4R7MK	4.7	±20%	45	0.50	295	7.96	3,000
LBMF1608T100(_K)	10	K=10%, M=±20%	40	1.20	200	2.52	3,000
LBMF1608T220(_K)	22	K=10%, M=±20%	16	3.70	130	2.52	3,000
LBMF1608T470(_K)	47	K=10%, M=±20%	11	5.80	90	2.52	3,000

(\_) - Insert Inductance Tolerance Code (K or M)

### 0805 Case Size High Current Type (LB C2012 Series)

Ordering Code	Inductance (μH)	Inductance Tolerance	Minimum Self Resonant Frequency (MHz)	DC Resistance (Ω) (±30%)	Maximum Rated Current (mA)	Measuring Frequency (MHz)	Tape & Reel Packaging Quantity
LBC2012-T1R0MK	1.0	±20%	100	0.19	620	7.96	3,000
LBC2012-T2R2MK	2.2	±20%	70	0.33	430	7.96	3,000
LBC2012-T4R7MK	4.7	±20%	45	0.50	295	7.96	3,000
LBC2012-T100MK	10	±20%	40	1.20	200	2.52	3,000
LBC2012-T220MK	22	±20%	16	3.70	130	2.52	3,000
LBC2012-T470MK	47	±20%	11	5.80	90	2.52	3,000

### 0806 Case Size High Current Type (LB C2016 Series)

Ordering Code	Inductance (μH)	Inductance Tolerance	Minimum Self Resonant Frequency (MHz)	DC Resistance (Ω) (±30%)	Maximum Rated Current (mA)	Measuring Frequency (MHz)	Tape & Reel Packaging Quantity
LBC2016-T1R0MK	1.0	±20%	100	0.10	690	7.96	2,000
LBC2016-T1R5MK	1.5	±20%	80	0.15	600	7.96	2,000
LBC2016-T2R2MK	2.2	±20%	70	0.20	520	7.96	2,000
LBC2016-T3R3MK	3.3	±20%	55	0.27	410	7.96	2,000
LBC2016-T4R7MK	4.7	±20%	45	0.37	355	7.96	2,000
LBC2016-T6R8MK	6.8	±20%	38	0.59	290	7.96	2,000
LBC2016-T100MK	10	±20%	32	0.82	245	2.52	2,000
LBC2016-T150MK	15	±20%	28	1.20	200	2.52	2,000
LBC2016-T220MK	22	±20%	16	1.80	165	2.52	2,000
LBC2016-T330MK	33	±20%	14	2.80	135	2.52	2,000
LBC2016-T470MK	47	±20%	11	4.30	110	2.52	2,000
LBC2016-T680MK	68	±20%	10	7.00	95	2.52	2,000
LBC2016-T101MK	100	±20%	8	8.00	75	0.796	2,000



### 1007 Case Size High Current Type (LB C2518 Series)

Ordering Code	Inductance (µH)	Inductance Tolerance	Minimum Self Resonant Frequency (MHz)	DC Resistance (Ω) (±30%)	Maximum Rated Current (mA)	Measuring Frequency (MHz)	Tape & Reel Packaging Quantity
LBC2518-T1R0MK	1.0	±20%	100	0.08	775	7.96	2,000
LBC2518-T1R5MK	1.5	±20%	80	0.11	660	7.96	2,000
LBC2518-T2R2MK	2.2	±20%	68	0.13	600	7.96	2,000
LBC2518-T3R3MK	3.3	±20%	54	0.16	500	7.96	2,000
LBC2518-T4R7MK	4.7	±20%	41	0.20	430	7.96	2,000
LBC2518-T6R8MK	6.8	±20%	38	0.30	360	7.96	2,000
LBC2518-T100MK	10	±20%	30	0.36	300	2.52	2,000
LBC2518-T150MK	15	±20%	23	0.65	250	2.52	2,000
LBC2518-T220MK	22	±20%	19	0.77	210	2.52	2,000
LBC2518-T330MK	33	±20%	15	1.50	170	2.52	2,000
LBC2518-T470MK	47	±20%	12	1.90	150	2.52	2,000
LBC2518-T680MK	68	±20%	9.5	2.80	120	2.52	2,000
LBC2518-T101MK	100	±20%	9.0	3.70	100	0.796	2,000
LBC2518-T151MK	150	±20%	7.0	6.10	85	0.796	2,000
LBC2518-T221MK	220	±20%	5.5	8.40	70	0.796	2,000
LBC2518-T331MK	330	±20%	4.5	12.30	60	0.796	2,000
LBC2518-T471MK	470	±20%	3.5	22.00	45	0.796	2,000
LBC2518-T681MK	680	±20%	3.0	28.00	35	0.796	2,000

### 0805 Case Size Low RDC Type (LB R2012 Series)

Ordering Code	Inductance (µH)	Inductance Tolerance	Minimum Self Resonant Frequency (MHz)	DC Resistance (Ω) (±30%)	Maximum Rated Current (mA)	Measuring Frequency (MHz)	Tape & Reel Packaging Quantity
LBR2012-T1R0MK	1.0	±20%	100	0.07	200	7.96	3,000
LBR2012-T2R2MK	2.2	±20%	80	0.13	175	7.96	3,000
LBR2012-T4R7MK	4.7	±20%	45	0.24	150	7.96	3,000
LBR2012-T100MK	10	±20%	32	0.36	125	2.52	3,000
LBR2012-T220MK	22	±20%	16	1.00	100	2.52	3,000
LBR2012-T470MK	47	±20%	11	1.70	75	2.52	3,000
LBR2012-T101MK	100	±20%	8	4.00	50	0.796	3,000

### 1007 Case Size Low RDC Type (LB R2518 Series)

Ordering Code	Inductance (µH)	Inductance Tolerance	Minimum Self Resonant Frequency (MHz)	DC Resistance (Ω) (±30%)	Maximum Rated Current (mA)	Measuring Frequency (MHz)	Tape & Reel Packaging Quantity
LBR2518-T1R0MK	1.0	±20%	100	0.045	400	7.96	2,000
LBR2518-T2R2MK	2.2	±20%	68	0.07	280	7.96	2,000
LBR2518-T4R7MK	4.7	±20%	45	0.1	200	7.96	2,000
LBR2518-T100MK	10	±20%	30	0.19	180	2.52	2,000
LBR2518-T220MK	22	±20%	19	0.44	120	2.52	2,000
LBR2518-T470MK	47	±20%	11	0.84	95	2.52	2,000
LBR2518-T101MK	100	±20%	9	1.89	75	0.796	2,000

## Wire Wound Chip Inductors - CB Series

**Features:**

- Small size wound chip inductor with high current
- Dimension without directional influence on mountability and characteristics

**Operating Temperature:**

- -25°C to +105°C (including self-generated heat)

**Applications:**

- Digital Still Cameras (DSC), Digital Video Cameras (DVC), PDA's and other portable digital equipment
- For DC-DC converter circuit

### Part Numbering Table

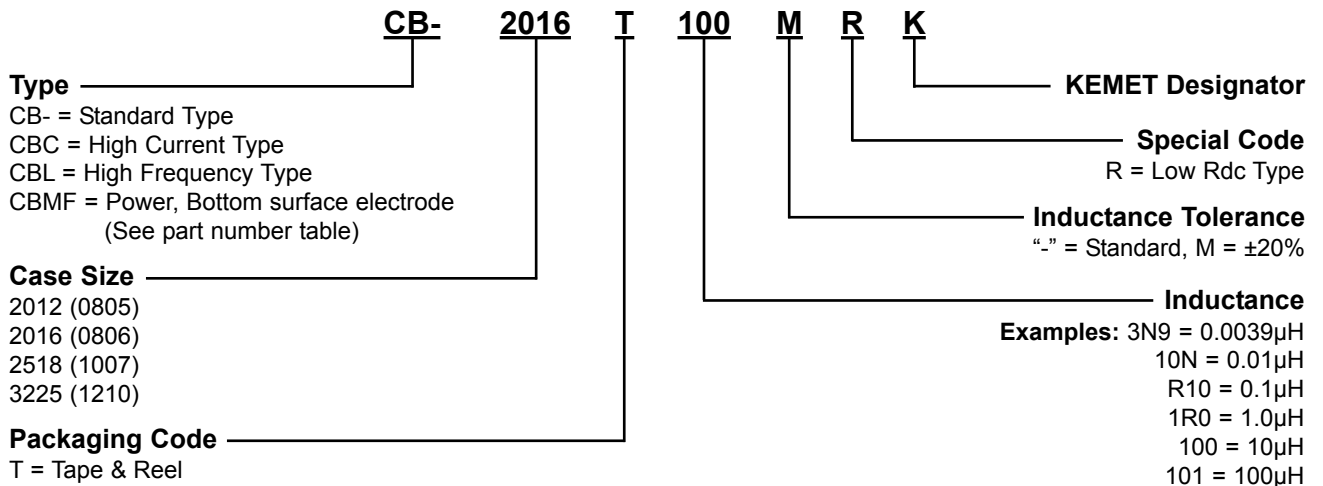

### Dimension Table in millimeters (inches)

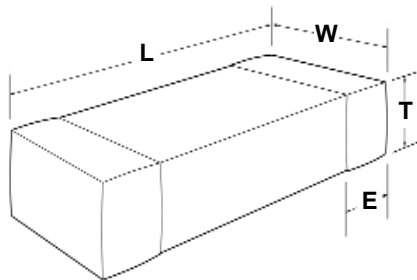

Dim. Code	EIA Case Size	L Length (inches)	W Width (inches)	T Thickness Maximum (inches)	E (inches)
1608	0603	1.6 ±0.2 (0.063 ±0.008)	0.8 ±0.2 (0.031 ±0.008)	0.8 ±0.2 (0.031 ±0.008)	0.4 ±0.15 (0.015 ±0.006)
2012	0805	2.0 ±0.2 (0.079 ±0.008)	1.25 ±0.2 (0.049 ±0.008)	1.25 ±0.2 (0.049 ±0.008)	0.5 ±0.2 (0.02 ±0.008)
2016	0806	2.0 ±0.2 (0.079 ±0.008)	1.6 ±0.2 (0.063 ±0.008)	1.6 ±0.2 (0.063 ±0.008)	0.5 ±0.2 (0.02 ±0.008)
2518	1007	2.5 ±0.2 (0.098 ±0.008)	1.8 ±0.2 (0.071 ±0.008)	1.8 ±0.2 (0.071 ±0.008)	0.5 ±0.2 (0.02 ±0.008)
3225	1210	3.2 ±0.2 (0.126 ±0.008)	2.5 ±0.2 (0.098 ±0.008)	2.5 ±0.2 (0.098 ±0.008)	0.6 ±0.3 (0.024 ±0.012)





### 0805 Case Size Low RDC Type (CB 2012 Series)

Ordering Code	Inductance (μH)	Inductance Tolerance	Minimum Self Resonant Frequency (MHz)	DC Resistance (Ω) (±30%)	Maximum Rated Current (mA)		Measuring Frequency (MHz)	Tape & Reel Packaging Quantity
					1	2		
CB-2012T2R2MRK	2.2	±20%	80	0.23	410	770	7.96	3,000
CB-2012T4R7MRK	4.7	±20%	45	0.40	300	580	7.96	3,000
CB-2012T100MRK	10	±20%	32	0.50	200	520	2.52	3,000
CB-2012T220MRK	22	±20%	16	1.70	135	280	2.52	3,000
CB-2012T470MRK	47	±20%	11	3.70	90	190	2.52	3,000

### 0806 Case Size Low RDC Type (CB 2016 Series)

Ordering Code	Inductance (μH)	Inductance Tolerance	Minimum Self Resonant Frequency (MHz)	DC Resistance (Ω) (±30%)	Maximum Rated Current (mA)		Measuring Frequency (MHz)	Tape & Reel Packaging Quantity
					1	2		
CB-2016T2R2M-K	2.2	±20%	70	0.13	510	1000	7.96	2,000
CB-2016T4R7M-K	4.7	±20%	45	0.25	340	740	7.96	2,000
CB-2016T100M-K	10	±20%	32	0.50	250	520	2.52	2,000
CB-2016T220M-K	22	±20%	16	1.00	165	370	2.52	2,000
CB-2016T470M-K	47	±20%	11	2.40	110	240	2.52	2,000

### 1007 Case Size Low RDC Type (CB 2518 Series)

Ordering Code	Inductance (μH)	Inductance Tolerance	Minimum Self Resonant Frequency (MHz)	DC Resistance (Ω) (±30%)	Maximum Rated Current (mA)		Measuring Frequency (MHz)	Tape & Reel Packaging Quantity
					1	2		
CB-2518T2R2M-K	2.2	±20%	68	0.09	510	1300	7.96	2,000
CB-2518T4R7M-K	4.7	±20%	46	0.13	340	1100	7.96	2,000
CB-2518T100M-K	10	±20%	30	0.25	250	820	2.52	2,000
CB-2518T220M-K	22	±20%	19	0.50	165	580	2.52	2,000
CB-2518T470M-K	47	±20%	12	0.95	110	420	2.52	2,000

### 0805 Case Size High Current Type (CBC 2012 Series)

Ordering Code	Inductance (μH)	Inductance Tolerance	Minimum Self Resonant Frequency (MHz)	DC Resistance (Ω) (±30%)	Maximum Rated Current (mA)		Measuring Frequency (MHz)	Tape & Reel Packaging Quantity
					1	2		
CBC2012T1R0M-K	1.0	±20%	100	0.19	700	840	7.96	3,000
CBC2012T2R2M-K	2.2	±20%	70	0.33	530	640	7.96	3,000
CBC2012T4R7M-K	4.7	±20%	45	0.50	360	520	7.96	3,000
CBC2012T100M-K	10	±20%	40	1.20	240	340	2.52	3,000
CBC2012T220M-K	22	±20%	16	3.70	170	190	2.52	3,000
CBC2012T470M-K	47	±20%	11	5.80	120	150	2.52	3,000

### 0806 Case Size High Current Type (CBC 2016 Series)

Ordering Code	Inductance (μH)	Inductance Tolerance	Minimum Self Resonant Frequency (MHz)	DC Resistance (Ω) (±30%)	Maximum Rated Current (mA)		Measuring Frequency (MHz)	Tape & Reel Packaging Quantity
					1	2		
CBC2016T1R0M-K	1.0	±20%	100	0.1	1100	1100	7.96	3,000
CBC2016T1R5M-K	1.5	±20%	80	0.15	1000	1000	7.96	3,000
CBC2016T2R2M-K	2.2	±20%	70	0.20	750	720	7.96	3,000
CBC2016T3R3M-K	3.3	±20%	55	0.27	600	610	7.96	3,000
CBC2016T4R7M-K	4.7	±20%	45	0.37	550	530	7.96	3,000
CBC2016T6R8M-K	6.8	±20%	38	0.59	450	450	7.96	3,000
CBC2016T100( )-K	10	K=10%, M=20%	32	0.82	380	350	2.52	3,000
CBC2016T150( )-K	15	K=10%, M=20%	28	1.2	300	300	2.52	3,000
CBC2016T220( )-K	22	K=10%, M=20%	16	1.8	250	240	2.52	3,000
CBC2016T330( )-K	33	K=10%, M=20%	14	2.8	220	220	2.52	3,000
CBC2016T470( )-K	47	K=10%, M=20%	11	4.3	150	150	2.52	3,000
CBC2016T680( )-K	68	K=10%, M=20%	10	7	130	130	2.52	3,000
CBC2016T101( )-K	100	K=10%, M=20%	8	8	110	110	0.796	3,000

( ) - Insert Inductance Tolerance Code (K or M)

\*For rated current of ordinary small power choke coils, please refer to the rated current (1) in the above table.

\*For current (2) is the current for instantaneous flow such as plunging current of DC/DC converter.

In case of usage in the circuit where large current may be semicontinuously applied over 5 minutes with auto recovery circuit, etc, please contact our sales section before practical application.

Rated current (1): Current value to guarantee -30% of nominal inductance

Rated current (2): Current value to guarantee component temperature within AT = 40°C with current flow. (It's not the current to guarantee the inductance value)



### 1007 Case Size High Current Type (CBC 2518 Series)

Ordering Code	Inductance (µH)	Inductance Tolerance	Minimum Self Resonant Frequency (MHz)	DC Resistance (Ω) (±30%)	Maximum Rated Current (mA)		Measuring Frequency (MHz)	Tape & Reel Packaging Quantity
					1	2		
CBC2518T1R0M-K	1.0	±20%	100	0.08	1000	1200	7.96	2,000
CBC2518T2R2M-K	2.2	±20%	68	0.13	890	1100	7.96	2,000
CBC2518T4R7M-K	4.7	±20%	41	0.20	680	920	7.96	2,000
CBC2518T100M-K	10	±20%	30	0.36	480	680	2.52	2,000
CBC2518T220M-K	22	±20%	19	0.77	320	460	2.52	2,000
CBC2518T470M-K	47	±20%	12	1.90	240	290	2.52	2,000
CBC2518T101M-K	100	±20%	9	3.7	160	170	0.796	2,000
CBC2518T221M-K	220	±20%	5.5	8.4	115	110	0.796	2,000
CBC2518T471M-K	470	±20%	3.5	22	80	70	0.796	2,000
CBC2518T681M-K	680	±20%	3	28	65	60	0.796	2,000

### 1210 Case Size High Current Type (CBC 3225 Series)

Ordering Code	Inductance (µH)	Inductance Tolerance	Minimum Self Resonant Frequency (MHz)	DC Resistance (Ω) (±30%)	Maximum Rated Current (mA)		Measuring Frequency (MHz)	Tape & Reel Packaging Quantity
					1	2		
CBC3225T1R0MRK	1.0	±20%	250	0.055	2000	1440	0.1	1,000
CBC3225T1R5MRK	1.5	±20%	220	0.06	2000	1310	0.1	1,000
CBC3225T2R2MRK	2.2	±20%	190	0.08	2000	1130	0.1	1,000
CBC3225T3R3MRK	3.3	±20%	160	0.095	1800	1040	0.1	1,000
CBC3225T4R7MRK	4.7	±20%	70	0.1	1250	1010	0.1	1,000
CBC3225T6R8MRK	6.8	±20%	50	0.12	930	940	0.1	1,000
CBC3225T100( )RK	10	K=±10%, M=±20%	23	0.133	900	900	0.1	1,000
CBC3225T150( )RK	15	K=±10%, M=±20%	20	0.195	730	850	0.1	1,000
CBC3225T220( )RK	22	K=±10%, M=±20%	17	0.27	620	780	0.1	1,000
CBC3225T330( )RK	33	K=±10%, M=±20%	13	0.41	500	570	0.1	1,000
CBC3225T470( )RK	47	K=±10%, M=±20%	10	0.67	390	480	0.1	1,000
CBC3225T680( )RK	68	K=±10%, M=±20%	8	1	320	410	0.1	1,000
CBC3225T101( )RK	100	K=±10%, M=±20%	6	1.4	270	340	0.1	1,000

( ) - Insert Inductance Tolerance Code (K or M)

### 0805 Case Size Low Profile Type (CBL 2012 Series)

Ordering Code	Inductance (µH)	Inductance Tolerance	Minimum Self Resonant Frequency (MHz)	DC Resistance (Ω) (±30%)	Maximum Rated Current (mA)		Measuring Frequency (MHz)	Tape & Reel Packaging Quantity
					1	2		
CBL2012T4R7M-K	4.7	±20%	45	0.66	275	490	0.10	4,000
CBL2012T100M-K	10	±20%	32	1.00	205	370	0.10	4,000
CBL2012T470M-K	47	±20%	11	4.20	100	140	0.10	4,000

### 0603 Case Size Power, Bottom Surface Electrode Type (CBMF 1608 Series)

Ordering Code	Inductance (µH)	Inductance Tolerance	Minimum Self Resonant Frequency (MHz)	DC Resistance (Ω) (±30%)	Maximum Rated Current (mA)		Measuring Frequency (MHz)	Tape & Reel Packaging Quantity
					1	2		
CBMF1608T1R0MK	1.0	±20%	100	0.09	290	770	7.96	2,000
CBMF1608T2R2MK	2.2	±20%	80	0.17	190	560	7.96	2,000
CBMF1608T4R7MK	4.7	±20%	45	0.24	145	470	7.96	2,000
CBMF1608T100( )K	10.0	K = 10%, M = 20%	32	0.36	115	380	2.52	2,000
CBMF1608T220( )K	22	K = 10%, M = 20%	16	1.00	70	230	2.52	2,000
CBMF1608T470( )K	47	K = 10%, M = 20%	11	2.5	50	140	2.52	2,000

( ) - Insert Inductance Tolerance Code (K or M)

\*For rated current of ordinary small power choke coils, please refer to the rated current (1) in the above table.

\*For current (2) is the current for instantaneous flow such as plunging current of DC/DC converter.

In case of usage in the circuit where large current may be semicontinuously applied over 5 minutes with auto recovery circuit, etc, please contact our sales section before practical application.

Rated current (1): Current value to guarantee -30% of nominal inductance (at 20°C)

Rated current (2): Current value to guarantee component temperature within AT = 40°C with current flow. (It's not the current to guarantee the inductance value)

## Multilayer Chip Inductors for High Frequency - HK Series

**Features:**

- Multilayer inductor made of advanced ceramics with low resistivity silver used as internal conductors, provides excellent Q and SRF characteristics
- Multilayer block structure ensures outstanding reliability, high productivity and excellent product quality

**Applications:**

- Design to address surface mount inductor needs for applications above 100MHz
- Mobile phones and pagers
- High frequency circuits
- EMI counter measures in high frequency circuits

**Operating Temperature:**

- 0603: -55°C to +125°C
  - 1005: -55°C to +125°C\*  
-55°C to +85°C\*
  - 1608: -40°C to +85°C
  - 2125: -40°C to +85°C
- \* Depends on rated current.

### Part Numbering Table

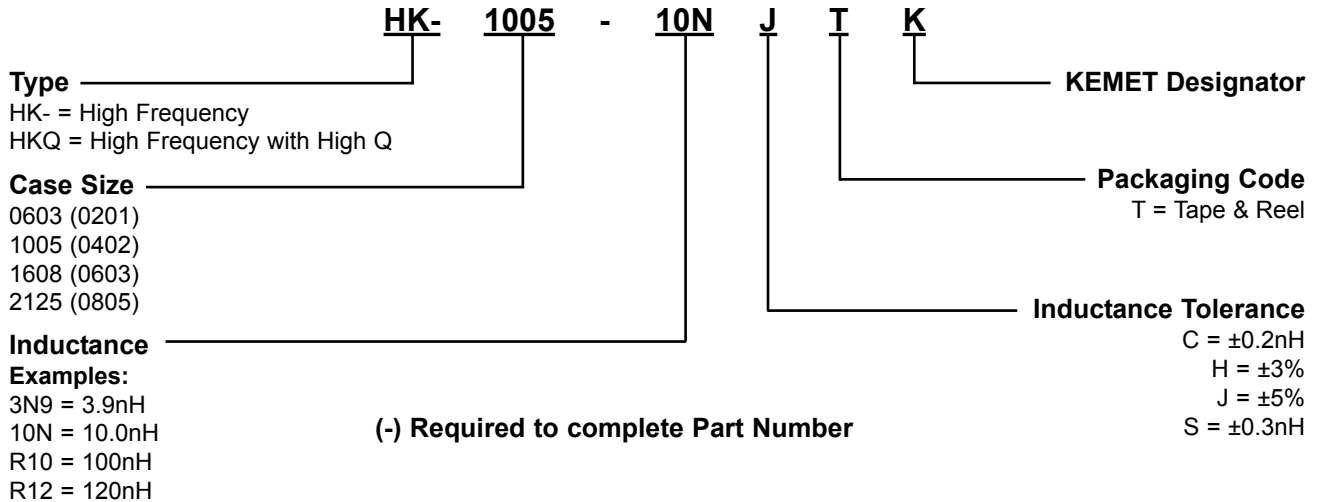

### Dimension Table in millimeters (inches)

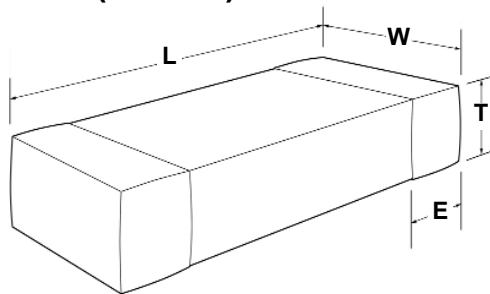

Dim. Code	EIA Case Size	L Length (inches)	W Width (inches)	T Thickness Maximum (inches)	E (inches)
0603	0201	0.6 ±0.03 (0.024 ±0.001)	0.3 ±0.03 (0.012 ±0.001)	0.3 ±0.03 (0.012 ±0.001)	0.15 ±0.05 (0.006 ±0.002)
1005	0402	1.0 ±0.05 (0.039 ±0.002)	0.5 ±0.05 (0.02 ±0.002)	0.5 ±0.05 (0.02 ±0.002)	0.25 ±0.10 (0.01 ±0.004)
1608	0603	1.6 ±0.15 (0.063 ±0.006)	0.8 ±0.15 (0.031 ±0.006)	0.8 ±0.15 (0.031 ±0.006)	0.3 ±0.2 (0.012 ±0.008)
2125	0805	2.0 +0.3/-0.1 (0.079 +0.012/-0.004)	1.25 ±0.2 (0.049 ±0.008)	0.85 ±0.2 1.0 +0.2/-0.3 (0.033 ±0.008) (0.039 +0.008/-0.012)	0.5 ±0.3 (0.020 ±0.012)



### 0201 Case Size Multilayer Chip Inductors for High Frequency (HK 0603 Series)

Ordering code	Inductance (nH)	Inductance Tolerance	Q min.	Measuring Frequency (MHz)	Typical Q					Self-resonant Frequency (MHz)		DC Resistance (Ω)		Maximum Rated Current (mA)	Thickness mm (inches)	Tape & Reel Packaging Quantity
					Frequency (MHz)					min.	typ.	max.	typ.			
					100	300	500	800	1000							
HK-0603-1N0STK	1.0	±0.3nH	4	100	6	12	17	22	27	10000	>13000	0.14	0.088	250	0.30 ±0.03 (0.012 ±0.001)	15,000
HK-0603-1N2STK	1.2	±0.3nH	4	100	6	12	16	21	25	10000	>13000	0.14	0.089	250	0.30 ±0.03 (0.012 ±0.001)	15,000
HK-0603-1N5STK	1.5	±0.3nH	4	100	6	12	15	20	23	10000	>13000	0.18	0.11	230	0.30 ±0.03 (0.012 ±0.001)	15,000
HK-0603-1N8STK	1.8	±0.3nH	4	100	6	12	15	20	23	10000	>13000	0.19	0.12	200	0.30 ±0.03 (0.012 ±0.001)	15,000
HK-0603-2N2STK	2.2	±0.3nH	4	100	6	12	15	20	22	8800	12500	0.22	0.14	200	0.30 ±0.03 (0.012 ±0.001)	15,000
HK-0603-2N7STK	2.7	±0.3nH	5	100	7	12	15	20	22	7700	11000	0.25	0.16	200	0.30 ±0.03 (0.012 ±0.001)	15,000
HK-0603-3N3STK	3.3	±0.3nH	5	100	7	12	15	20	22	6700	9600	0.30	0.19	180	0.30 ±0.03 (0.012 ±0.001)	15,000
HK-0603-3N9STK	3.9	±0.3nH	5	100	7	12	15	20	22	6000	8600	0.30	0.20	170	0.30 ±0.03 (0.012 ±0.001)	15,000
HK-0603-4N7STK	4.7	±0.3nH	5	100	7	12	15	19	21	5300	7600	0.40	0.25	150	0.30 ±0.03 (0.012 ±0.001)	15,000
HK-0603-5N6STK	5.6	±0.3nH	5	100	7	12	15	19	21	4600	6600	0.40	0.25	150	0.30 ±0.03 (0.012 ±0.001)	15,000
HK-0603-6N8JTK	6.8	±5%	5	100	7	11	14	18	20	3900	5600	0.48	0.30	150	0.30 ±0.03 (0.012 ±0.001)	15,000
HK-0603-8N2JTK	8.2	±5%	5	100	7	11	14	18	19	3400	4900	0.55	0.34	150	0.30 ±0.03 (0.012 ±0.001)	15,000
HK-0603-10NJTK	10	±5%	5	100	7	11	14	17	18	2900	4200	0.63	0.39	150	0.30 ±0.03 (0.012 ±0.001)	15,000
HK-0603-12NJTK	12	±5%	5	100	7	11	14	17	18	2700	3800	0.70	0.45	100	0.30 ±0.03 (0.012 ±0.001)	15,000
HK-0603-15NJTK	15	±5%	5	100	7	11	13	16	17	2300	3300	0.80	0.50	100	0.30 ±0.03 (0.012 ±0.001)	15,000
HK-0603-18NJTK	18	±5%	5	100	7	11	13	16	17	2100	3000	0.90	0.57	100	0.30 ±0.03 (0.012 ±0.001)	15,000
HK-0603-22NJTK	22	±5%	5	100	7	11	13	15	16	1800	2600	1.20	0.71	100	0.30 ±0.03 (0.012 ±0.001)	15,000
HK-0603-27NJTK	27	±5%	4	100	6	10	12	14	15	1800	2600	1.80	1.11	50	0.30 ±0.03 (0.012 ±0.001)	15,000
HK-0603-33NJTK	33	±5%	4	100	6	10	12	14	14	1700	2400	2.10	1.33	50	0.30 ±0.03 (0.012 ±0.001)	15,000
HK-0603-39NJTK	39	±5%	4	100	6	10	12	13	12	1500	2100	2.40	1.51	50	0.30 ±0.03 (0.012 ±0.001)	15,000
HK-0603-47NJTK	47	±5%	4	100	6	10	11	12	11	1300	1800	2.80	1.74	50	0.30 ±0.03 (0.012 ±0.001)	15,000
HK-0603-56NJTK	56	±5%	4	100	6	10	11	11	10	1100	1600	3.00	1.85	50	0.30 ±0.03 (0.012 ±0.001)	15,000
HK-0603-68NJTK	68	±5%	4	100	6	10	11	11	10	1100	1500	3.00	2.30	50	0.30 ±0.03 (0.012 ±0.001)	15,000
HK-0603-82NJTK	82	±5%	4	100	6	10	11	10	8	1000	1400	3.50	2.60	50	0.30 ±0.03 (0.012 ±0.001)	15,000
HK-0603-R10JTK	100	±5%	4	100	6	9	10	9	6	900	1200	4.00	3.00	40	0.30 ±0.03 (0.012 ±0.001)	15,000



### 0402 Case Size Multilayer Chip Inductors for High Frequency (HK 1005 Series)

Ordering code	Inductance (nH)	Inductance Tolerance	Q min.	Measuring Frequency (MHz)	Typical Q					Self-resonant Frequency (MHz)		DC Resistance (Ω)		Maximum Rated Current (mA)		Thickness mm (inches)	Tape & Reel Packaging Quantity
					Frequency (MHz)					min.	typ.	max.	typ.	-55° to 125°C	-55° to 85°C		
					100	300	500	800	1000								
HK-1005-1N0STK	1.0	±0.3nH	8	100	11	25	34	43	52	10000	>13000	0.08	0.04	300	900	0.50 ±0.05 (0.02 ±0.002)	10,000
HK-1005-1N2STK	1.2	±0.3nH	8	100	11	25	35	44	52	10000	>13000	0.09	0.04	300	900	0.50 ±0.05 (0.02 ±0.002)	10,000
HK-1005-1N5STK	1.5	±0.3nH	8	100	11	24	33	44	48	6000	>13000	0.10	0.05	300	850	0.50 ±0.05 (0.02 ±0.002)	10,000
HK-1005-1N8STK	1.8	±0.3nH	8	100	11	23	30	36	42	6000	11000	0.12	0.06	300	700	0.50 ±0.05 (0.02 ±0.002)	10,000
HK-1005-2N0STK	2	±0.3nH	8	100	11	21	27	34	39	6000	10500	0.12	0.06	300	700	0.50 ±0.05 (0.02 ±0.002)	10,000
HK-1005-2N2STK	2.2	±0.3nH	8	100	10	18	25	31	36	6000	10000	0.13	0.07	300	700	0.50 ±0.05 (0.02 ±0.002)	10,000
HK-1005-2N4STK	2.4	±0.3nH	8	100	10	18	24	31	35	6000	9500	0.13	0.07	300	650	0.50 ±0.05 (0.02 ±0.002)	10,000
HK-1005-2N7STK	2.7	±0.3nH	8	100	10	18	24	31	34	6000	9000	0.13	0.08	300	650	0.50 ±0.05 (0.02 ±0.002)	10,000
HK-1005-3N0STK	3	±0.3nH	8	100	10	18	24	31	35	6000	8500	0.16	0.09	300	600	0.50 ±0.05 (0.02 ±0.002)	10,000
HK-1005-3N3STK	3.3	±0.3nH	8	100	10	18	24	31	35	6000	8000	0.16	0.10	300	550	0.50 ±0.05 (0.02 ±0.002)	10,000
HK-1005-3N6STK	3.6	±0.3nH	8	100	10	18	24	31	35	5000	7500	0.20	0.11	300	500	0.50 ±0.05 (0.02 ±0.002)	10,000
HK-1005-3N9STK	3.9	±0.3nH	8	100	10	18	24	31	35	4000	7000	0.21	0.12	300	500	0.50 ±0.05 (0.02 ±0.002)	10,000
HK-1005-4N3STK	4.3	±0.3nH	8	100	10	18	24	31	35	4000	6500	0.20	0.12	300	500	0.50 ±0.05 (0.02 ±0.002)	10,000
HK-1005-4N7STK	4.7	±0.3nH	8	100	10	18	24	31	34	4000	6000	0.21	0.12	300	500	0.50 ±0.05 (0.02 ±0.002)	10,000
HK-1005-5N1STK	5.1	±0.3nH	8	100	10	18	24	31	34	4000	5800	0.21	0.13	300	450	0.50 ±0.05 (0.02 ±0.002)	10,000
HK-1005-5N6STK	5.6	±0.3nH	8	100	10	18	24	30	35	4000	5700	0.23	0.15	300	430	0.50 ±0.05 (0.02 ±0.002)	10,000
HK-1005-6N2STK	6.2	±0.3nH	8	100	10	18	24	30	34	3900	5600	0.25	0.16	300	430	0.50 ±0.05 (0.02 ±0.002)	10,000
HK-1005-6N8JTK	6.8	±5%	8	100	10	18	23	29	32	3900	5500	0.25	0.17	300	430	0.50 ±0.05 (0.02 ±0.002)	10,000
HK-1005-7N5JTK	7.5	±5%	8	100	10	18	23	29	32	3700	5200	0.25	0.18	300	400	0.50 ±0.05 (0.02 ±0.002)	10,000
HK-1005-8N2JTK	8.2	±5%	8	100	10	18	23	29	31	3600	4900	0.28	0.21	300	380	0.50 ±0.05 (0.02 ±0.002)	10,000
HK-1005-9N1JTK	9.1	±5%	8	100	10	18	23	29	31	3400	4500	0.30	0.22	300	360	0.50 ±0.05 (0.02 ±0.002)	10,000
HK-1005-10NJTK	10	±5%	8	100	10	18	23	29	31	3200	4300	0.31	0.23	300	340	0.50 ±0.05 (0.02 ±0.002)	10,000
HK-1005-12NJTK	12	±5%	8	100	11	18	23	29	31	2700	3900	0.40	0.28	300	330	0.50 ±0.05 (0.02 ±0.002)	10,000
HK-1005-15NJTK	15	±5%	8	100	11	18	23	28	30	2300	3500	0.46	0.31	300	320	0.50 ±0.05 (0.02 ±0.002)	10,000
HK-1005-18NJTK	18	±5%	8	100	11	18	23	28	30	2100	3100	0.55	0.35	300	310	0.50 ±0.05 (0.02 ±0.002)	10,000
HK-1005-22NJTK	22	±5%	8	100	11	17	22	26	27	1900	2800	0.60	0.42	300	300	0.50 ±0.05 (0.02 ±0.002)	10,000
HK-1005-27NJTK	27	±5%	8	100	11	17	21	25	26	1600	2300	0.70	0.47	300	300	0.50 ±0.05 (0.02 ±0.002)	10,000
HK-1005-33NJTK	33	±5%	8	100	11	16	20	23	22	1300	1900	0.80	0.50	200	250	0.50 ±0.05 (0.02 ±0.002)	10,000
HK-1005-39NJTK	39	±5%	8	100	11	16	20	23	21	1200	1700	0.90	0.52	200	250	0.50 ±0.05 (0.02 ±0.002)	10,000
HK-1005-47NJTK	47	±5%	8	100	11	16	19	21	18	1000	1500	1.00	0.58	200	230	0.50 ±0.05 (0.02 ±0.002)	10,000
HK-1005-56NJTK	56	±5%	8	100	11	16	18	18	16	750	1300	1.00	0.61	200	220	0.50 ±0.05 (0.02 ±0.002)	10,000
HK-1005-68NJTK	68	±5%	8	100	11	15	17	18	11	750	1200	1.20	0.70	180	200	0.50 ±0.05 (0.02 ±0.002)	10,000
HK-1005-82NJTK	82	±5%	8	100	10	14	16	15	6	600	1100	1.30	0.81	150	200	0.50 ±0.05 (0.02 ±0.002)	10,000
HK-1005-R10JTK	100	±5%	8	100	10	14	14	12	-	600	1000	1.50	0.94	150	200	0.50 ±0.05 (0.02 ±0.002)	10,000
HK-1005-R12JTK	120	±5%	8	100	10	12	10	-	-	600	800	1.60	1.10	150	200	0.50 ±0.05 (0.02 ±0.002)	10,000



### 0603 Case Size Multilayer Chip Inductors for High Frequency (HK 1608 Series)

Ordering Code	Inductance (nH)	Inductance Tolerance	Q min.	Measuring Frequency (MHz)	Typical Q					Self-resonant Frequency (MHz)		DC Resistance (Ω)		Maximum Rated Current (mA)	Thickness mm (inches)	Tape & Reel Packaging Quantity
					Frequency (MHz)					min.	typ.	max.	typ.			
					100	300	500	800	1000							
HK-1608-1N0STK	1.0	±0.3nH	8	100	14	30	40	70	90	10000	>13000	0.05	0.015	300	0.8 ±0.15 (0.031 ±0.006)	4,000
HK-1608-1N2STK	1.2	±0.3nH	8	100	14	30	40	70	90	10000	>13000	0.05	0.015	300	0.8 ±0.15 (0.031 ±0.006)	4,000
HK-1608-1N5STK	1.5	±0.3nH	8	100	14	26	34	47	50	6000	>13000	0.10	0.03	300	0.8 ±0.15 (0.031 ±0.006)	4,000
HK-1608-1N8STK	1.8	±0.3nH	8	100	10	18	24	30	34	6000	>13000	0.10	0.06	300	0.8 ±0.15 (0.031 ±0.006)	4,000
HK-1608-2N2STK	2.2	±0.3nH	8	100	12	22	29	37	40	6000	12000	0.10	0.06	300	0.8 ±0.15 (0.031 ±0.006)	4,000
HK-1608-2N7STK	2.7	±0.3nH	10	100	13	24	32	41	45	6000	11000	0.10	0.06	300	0.8 ±0.15 (0.031 ±0.006)	4,000
HK-1608-3N3STK	3.3	±0.3nH	10	100	14	25	33	42	47	6000	9000	0.12	0.06	300	0.8 ±0.15 (0.031 ±0.006)	4,000
HK-1608-3N9STK	3.9	±0.3nH	10	100	13	25	33	42	46	6000	8000	0.14	0.07	300	0.8 ±0.15 (0.031 ±0.006)	4,000
HK-1608-4N7STK	4.7	±0.3nH	10	100	13	25	33	42	47	4000	6500	0.16	0.08	300	0.8 ±0.15 (0.031 ±0.006)	4,000
HK-1608-5N6STK	5.6	±0.3nH	10	100	14	25	33	42	46	4000	5800	0.18	0.09	300	0.8 ±0.15 (0.031 ±0.006)	4,000
HK-1608-6N8JTK	6.8	±5%	10	100	14	25	33	43	47	4000	5600	0.22	0.11	300	0.8 ±0.15 (0.031 ±0.006)	4,000
HK-1608-8N2JTK	8.2	±5%	10	100	14	26	34	44	48	3500	5200	0.24	0.13	300	0.8 ±0.15 (0.031 ±0.006)	4,000
HK-1608-10NJTK	10	±5%	12	100	14	26	34	43	47	3400	4600	0.26	0.16	300	0.8 ±0.15 (0.031 ±0.006)	4,000
HK-1608-12NJTK	12	±5%	12	100	14	27	35	45	49	2600	4000	0.28	0.17	300	0.8 ±0.15 (0.031 ±0.006)	4,000
HK-1608-15NJTK	15	±5%	12	100	15	28	37	46	51	2300	3400	0.32	0.20	300	0.8 ±0.15 (0.031 ±0.006)	4,000
HK-1608-18NJTK	18	±5%	12	100	15	27	36	44	48	2000	3000	0.35	0.21	300	0.8 ±0.15 (0.031 ±0.006)	4,000
HK-1608-22NJTK	22	±5%	12	100	16	28	36	44	47	1600	2900	0.40	0.25	300	0.8 ±0.15 (0.031 ±0.006)	4,000
HK-1608-27NJTK	27	±5%	12	100	16	29	37	45	46	1400	2200	0.45	0.28	300	0.8 ±0.15 (0.031 ±0.006)	4,000
HK-1608-33NJTK	33	±5%	12	100	17	31	40	46	47	1200	1800	0.55	0.35	300	0.8 ±0.15 (0.031 ±0.006)	4,000
HK-1608-39NJTK	39	±5%	12	100	18	31	39	44	44	1100	1600	0.60	0.38	300	0.8 ±0.15 (0.031 ±0.006)	4,000
HK-1608-47NJTK	47	±5%	12	100	17	28	34	35	34	900	1600	0.70	0.45	300	0.8 ±0.15 (0.031 ±0.006)	4,000
HK-1608-56NJTK	56	±5%	12	100	17	28	34	34	31	900	1400	0.75	0.50	300	0.8 ±0.15 (0.031 ±0.006)	4,000
HK-1608-68NJTK	68	±5%	12	100	18	29	34	30	22	700	1200	0.85	0.55	300	0.8 ±0.15 (0.031 ±0.006)	4,000
HK-1608-82NJTK	82	±5%	12	100	18	28	33	27	-	600	1100	0.95	0.60	300	0.8 ±0.15 (0.031 ±0.006)	4,000
HK-1608-R10JTK	100	±5%	12	100	18	27	28	16	-	600	1000	1.00	0.65	300	0.8 ±0.15 (0.031 ±0.006)	4,000
HK-1608-R12JTK	120	±5%	8	50	16	24	23	-	-	500	800	1.20	0.68	300	0.8 ±0.15 (0.031 ±0.006)	4,000
HK-1608-R15JTK	150	±5%	8	50	13	19	16	-	-	500	800	1.20	0.73	300	0.8 ±0.15 (0.031 ±0.006)	4,000
HK-1608-R18JTK	180	±5%	8	50	13	18	12	-	-	400	700	1.30	0.85	300	0.8 ±0.15 (0.031 ±0.006)	4,000
HK-1608-R22JTK	220	±5%	8	50	12	16	-	-	-	400	600	1.50	0.95	300	0.8 ±0.15 (0.031 ±0.006)	4,000
HK-1608-R27JTK	270	±5%	8	50	14	15	-	-	-	400	550	1.90	1.34	150	0.8 ±0.15 (0.031 ±0.006)	4,000
HK-1608-R33JTK	330	±5%	8	50	14	-	-	-	-	350	480	2.10	1.53	150	0.8 ±0.15 (0.031 ±0.006)	4,000
HK-1608-R39JTK	390	±5%	8	50	13	-	-	-	-	350	410	2.30	1.72	150	0.8 ±0.15 (0.031 ±0.006)	4,000
HK-1608-R47JTK	470	±5%	8	50	13	-	-	-	-	300	360	2.60	2.04	150	0.8 ±0.15 (0.031 ±0.006)	4,000



### 8005 Case Size Multilayer Chip Inductors for High Frequency (HK 2125 Series)

Ordering Code	Inductance (nH)	Inductance Tolerance	Q min.	Measuring Frequency (MHz)	Typical Q					Self-resonant Frequency (MHz)		DC Resistance (Ω)		Maximum Rated Current (mA)	Thickness mm (inches)	Tape & Reel Packaging Quantity
					Frequency (MHz)					min.	typ.	max.	typ.			
					100	300	500	800	1000							
HK-2125-1N5STK	1.5	±0.3nH	10	100	21	39	57	61	68	4000	>6000	0.10	0.02	300	0.85 ±0.2 (0.033 ±0.008)	4,000
HK-2125-1N8STK	1.8	±0.3nH	10	100	18	35	49	55	59	4000	>6000	0.10	0.02	300	0.85 ±0.2 (0.033 ±0.008)	4,000
HK-2125-2N2STK	2.2	±0.3nH	10	100	18	33	46	53	58	4000	>6000	0.10	0.03	300	0.85 ±0.2 (0.033 ±0.008)	4,000
HK-2125-2N7STK	2.7	±0.3nH	12	100	19	36	50	56	60	4000	>6000	0.10	0.03	300	0.85 ±0.2 (0.033 ±0.008)	4,000
HK-2125-3N3STK	3.3	±0.3nH	12	100	16	29	40	47	51	4000	>6000	0.13	0.04	300	0.85 ±0.2 (0.033 ±0.008)	4,000
HK-2125-3N9STK	3.9	±0.3nH	12	100	18	33	46	54	60	4000	>6000	0.15	0.05	300	0.85 ±0.2 (0.033 ±0.008)	4,000
HK-2125-4N7STK	4.7	±0.3nH	12	100	18	34	46	55	60	3500	>6000	0.20	0.05	300	0.85 ±0.2 (0.033 ±0.008)	4,000
HK-2125-5N6STK	5.6	±0.3nH	15	100	20	38	51	60	66	3200	5400	0.23	0.05	300	0.85 ±0.2 (0.033 ±0.008)	4,000
HK-2125-6N8JTK	6.8	±5%	15	100	20	39	52	63	69	2800	4200	0.25	0.06	300	0.85 ±0.2 (0.033 ±0.008)	4,000
HK-2125-8N2JTK	8.2	±5%	15	100	21	40	54	63	70	2400	3700	0.28	0.07	300	0.85 ±0.2 (0.033 ±0.008)	4,000
HK-2125-10NJTK	10	±5%	15	100	20	38	51	60	67	2100	3100	0.30	0.09	300	0.85 ±0.2 (0.033 ±0.008)	4,000
HK-2125-12NJTK	12	±5%	15	100	21	39	52	60	67	1900	3000	0.35	0.10	300	0.85 ±0.2 (0.033 ±0.008)	4,000
HK-2125-15NJTK	15	±5%	15	100	22	42	55	63	72	1600	2600	0.40	0.11	300	0.85 ±0.2 (0.033 ±0.008)	4,000
HK-2125-18NJTK	18	±5%	15	100	24	44	57	63	72	1500	2300	0.45	0.13	300	0.85 ±0.2 (0.033 ±0.008)	4,000
HK-2125-22NJTK	22	±5%	18	100	23	43	55	60	69	1400	2100	0.50	0.16	300	0.85 ±0.2 (0.033 ±0.008)	4,000
HK-2125-27NJTK	27	±5%	18	100	23	42	53	58	68	1300	1800	0.55	0.17	300	0.85 ±0.2 (0.033 ±0.008)	4,000
HK-2125-33NJTK	33	±5%	18	100	24	43	54	55	60	1200	1700	0.60	0.19	300	0.85 ±0.2 (0.033 ±0.008)	4,000
HK-2125-39NJTK	39	±5%	18	100	23	41	50	47	47	1000	1400	0.65	0.25	300	0.85 ±0.2 (0.033 ±0.008)	4,000
HK-2125-47NJTK	47	±5%	18	100	23	41	49	43	41	900	1200	0.70	0.26	300	1.0 +0.2/-0.3 (0.039 +0.008/-0.012)	3,000
HK-2125-56NJTK	56	±5%	18	100	23	42	48	39	38	800	1100	0.75	0.28	300	1.0 +0.2/-0.3 (0.039 +0.008/-0.012)	3,000
HK-2125-68NJTK	68	±5%	18	100	25	42	45	30	-	700	900	0.80	0.33	300	1.0 +0.2/-0.3 (0.039 +0.008/-0.012)	3,000
HK-2125-82NJTK	82	±5%	18	100	24	41	41	-	-	600	800	0.90	0.37	300	1.0 +0.2/-0.3 (0.039 +0.008/-0.012)	3,000
HK-2125-R10JTK	100	±5%	18	100	23	37	37	-	-	600	800	0.90	0.40	300	1.0 +0.2/-0.3 (0.039 +0.008/-0.012)	3,000
HK-2125-R12JTK	120	±5%	13	50	22	33	29	-	-	500	700	0.95	0.43	300	1.0 +0.2/-0.3 (0.039 +0.008/-0.012)	3,000
HK-2125-R15JTK	150	±5%	13	50	22	34	26	-	-	500	700	1.00	0.46	300	1.0 +0.2/-0.3 (0.039 +0.008/-0.012)	3,000
HK-2125-R18JTK	180	±5%	13	50	23	34	20	-	-	400	600	1.10	0.50	300	1.0 +0.2/-0.3 (0.039 +0.008/-0.012)	3,000
HK-2125-R22JTK	220	±5%	12	50	20	23	-	-	-	350	550	1.20	0.75	300	1.0 +0.2/-0.3 (0.039 +0.008/-0.012)	3,000
HK-2125-R27JTK	270	±5%	12	50	20	19	-	-	-	300	480	0.30	0.85	300	1.0 +0.2/-0.3 (0.039 +0.008/-0.012)	3,000
HK-2125-R33JTK	330	±5%	12	50	22	15	-	-	-	250	400	1.40	0.90	300	1.0 +0.2/-0.3 (0.039 +0.008/-0.012)	3,000
HK-2125-R39JTK	390	±5%	10	50	17	12	-	-	-	250	400	1.30	0.85	300	1.0 +0.2/-0.3 (0.039 +0.008/-0.012)	3,000
HK-2125-R47JTK	470	±5%	10	50	17	-	-	-	-	200	350	0.50	0.95	300	1.0 +0.2/-0.3 (0.039 +0.008/-0.012)	3,000

## Multilayer Chip Inductors - LK/CK/CKP Series

**Features:**

- Internal printed coil structure creates a closed magnetic circuit which acts as a magnetic shield eliminating crosstalk, thus permitting higher mounting densities.
- Multilayer block structure yields higher reliability
- The smallest mH inductors in the world (LK1005 Series)
- Low profile below 1mm on 1206 case size (CKP Series)
- Low DC power dissipation due to Low Rdc with High Aspect Ratio internal conductor that stands on the Green Sheet and Printing technologies (CKP Series)

**Operating Temperature:**

- -40°C to +85°C

**Applications:**

- Any general circuit in portable equipment in which a compact size and high mounting densities are required (LK Series)
- Separation of analog and digital circuits (CK Series)
- Prevents interference between PLL and other digital circuits (CK Series)
- DC/DC convertor for mobile equipment, cellular phones, DSC and DVC (CK Series)

### Part Numbering Table

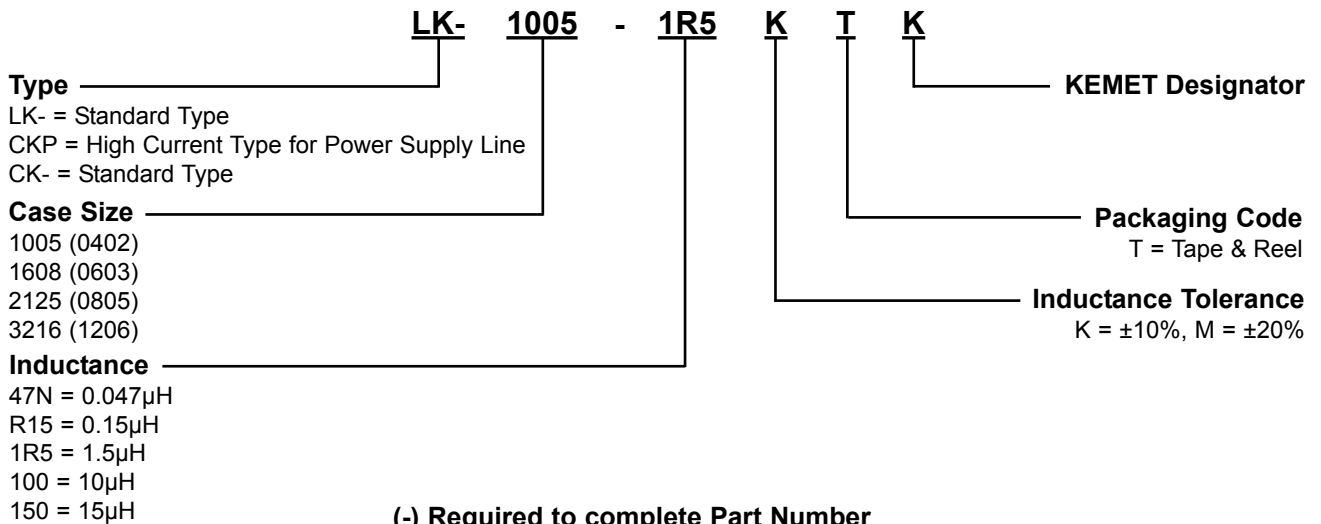

### Dimension Table in millimeters (inches)

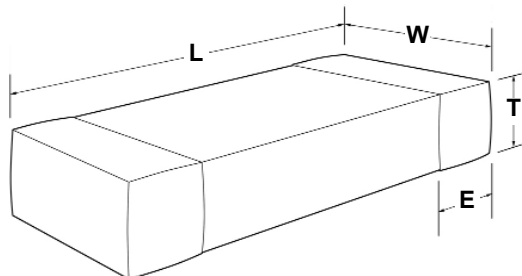

Dim. Code	EIA Case Size	L Length (inches)	W Width (inches)	T Thickness Maximum (inches)	E (inches)
1005	0402	1.0 ±0.05 (0.039 ±0.002)	0.50 ±0.05 (0.020 ±0.002)	0.50 ±0.05 (0.020 ±0.002)	0.25 ±0.10 (0.010 ±0.004)
1608	0603	1.6 ±0.15 (0.063 ±0.006)	0.8 ±0.15 (0.031 ±0.006)	0.8 ±0.15 (0.031 ±0.006)	0.3 ±0.2 (0.012 ±0.008)
2125	0805	2.0 +0.3/-0.1 (0.079 _0.012/-0.004)	1.25 ±0.2 (0.049 ±0.008)	0.85 ±0.2 1.25 ±0.2 (0.033 ±0.008) (0.049 ±0.008)	0.5 ±0.2 (0.02 ±0.008)
3216	1206	3.2 ±0.2 (0.126 ±0.008)	1.6 ±0.2 (0.063 ±0.008)	0.8 +0.10/-0.15 (0.031 +0.004/-0.008)	0.6 ±0.3 (0.024 ±0.012)





### 0402 Case Size Multilayer Chip Inductors (LK 1005 Series)

Ordering Code	Inductance (µH)	Inductance Tolerance	Q min.	Minimum Self Resonant Frequency (MHz)	Maximum DC Resistance (Ω)	Maximum Rated Current (mA)	Measuring Frequency (MHz)	Thickness mm (inches)	Tape & Reel Packaging Quantity
LK-1005-R12( )TK	0.12	K±10%. M±20%	10	180	0.70	25	25	0.5 ±0.05 (0.02 ±0.002)	10,000
LK-1005-R15( )TK	0.15	K±10%. M±20%	10	165	0.90	25	25	0.5 ±0.05 (0.02 ±0.002)	10,000
LK-1005-R18( )TK	0.18	K±10%. M±20%	10	150	1.10	25	25	0.5 ±0.05 (0.02 ±0.002)	10,000
LK-1005-R22( )TK	0.22	K±10%. M±20%	10	135	1.30	25	25	0.5 ±0.05 (0.02 ±0.002)	10,000
LK-1005-R27( )TK	0.27	K±10%. M±20%	10	120	1.50	25	25	0.5 ±0.05 (0.02 ±0.002)	10,000
LK-1005-R33( )TK	0.33	K±10%. M±20%	10	105	1.70	25	25	0.5 ±0.05 (0.02 ±0.002)	10,000
LK-1005-R39( )TK	0.39	K±10%. M±20%	20	85	0.60	10	10	0.5 ±0.05 (0.02 ±0.002)	10,000
LK-1005-R47( )TK	0.47	K±10%. M±20%	20	80	0.70	10	10	0.5 ±0.05 (0.02 ±0.002)	10,000
LK-1005-R56( )TK	0.56	K±10%. M±20%	20	75	0.80	10	10	0.5 ±0.05 (0.02 ±0.002)	10,000
LK-1005-R68( )TK	0.68	K±10%. M±20%	20	70	0.90	10	10	0.5 ±0.05 (0.02 ±0.002)	10,000
LK-1005-R82( )TK	0.82	K±10%. M±20%	20	65	1.00	10	10	0.5 ±0.05 (0.02 ±0.002)	10,000
LK-1005-1R0( )TK	1.0	K±10%. M±20%	20	60	1.10	10	10	0.5 ±0.05 (0.02 ±0.002)	10,000
LK-1005-1R2( )TK	1.2	K±10%. M±20%	20	55	1.25	10	10	0.5 ±0.05 (0.02 ±0.002)	10,000
LK-1005-1R5( )TK	1.5	K±10%. M±20%	20	50	1.40	10	10	0.5 ±0.05 (0.02 ±0.002)	10,000
LK-1005-1R8( )TK	1.8	K±10%. M±20%	20	45	1.55	10	10	0.5 ±0.05 (0.02 ±0.002)	10,000
LK-1005-2R2( )TK	2.2	K±10%. M±20%	20	40	1.70	10	10	0.5 ±0.05 (0.02 ±0.002)	10,000

( ) - Insert Inductance Tolerance Code (K or M)



### 0603 Case Size Multilayer Chip Inductors (LK 1608 Series)

Ordering Code	Inductance (µH)	Inductance Tolerance	Q min.	Minimum Self Resonant Frequency (MHz)	Maximum DC Resistance (Ω)	Maximum Rated Current (mA)	Measuring Frequency (MHz)	Thickness mm (inches)	Tape & Reel Packaging Quantity
LK-1608-47NMTK	0.047	±20%	10	260	0.30	50	50	0.8 ±0.15 (0.031 ±0.006)	4,000
LK-1608-68NMTK	0.068	±20%	10	250	0.30	50	50	0.8 ±0.15 (0.031 ±0.006)	4,000
LK-1608-82NMTK	0.082	±20%	10	245	0.30	50	50	0.8 ±0.15 (0.031 ±0.006)	4,000
LK-1608-R10( )TK	0.10	K±10%, M±20%	15	240	0.50	50	25	0.8 ±0.15 (0.031 ±0.006)	4,000
LK-1608-R12( )TK	0.12	K±10%, M±20%	15	205	0.50	50	25	0.8 ±0.15 (0.031 ±0.006)	4,000
LK-1608-R15( )TK	0.15	K±10%, M±20%	15	180	0.60	50	25	0.8 ±0.15 (0.031 ±0.006)	4,000
LK-1608-R18( )TK	0.18	K±10%, M±20%	15	165	0.60	50	25	0.8 ±0.15 (0.031 ±0.006)	4,000
LK-1608-R22( )TK	0.22	K±10%, M±20%	15	150	0.80	50	25	0.8 ±0.15 (0.031 ±0.006)	4,000
LK-1608-R27( )TK	0.27	K±10%, M±20%	15	136	0.80	50	25	0.8 ±0.15 (0.031 ±0.006)	4,000
LK-1608-R33( )TK	0.33	K±10%, M±20%	15	125	0.85	35	25	0.8 ±0.15 (0.031 ±0.006)	4,000
LK-1608-R39( )TK	0.39	K±10%, M±20%	15	110	1.00	35	25	0.8 ±0.15 (0.031 ±0.006)	4,000
LK-1608-R47( )TK	0.47	K±10%, M±20%	15	105	1.35	35	25	0.8 ±0.15 (0.031 ±0.006)	4,000
LK-1608-R56( )TK	0.56	K±10%, M±20%	15	95	1.55	35	25	0.8 ±0.15 (0.031 ±0.006)	4,000
LK-1608-R68( )TK	0.68	K±10%, M±20%	15	80	1.70	35	25	0.8 ±0.15 (0.031 ±0.006)	4,000
LK-1608-R82( )TK	0.82	K±10%, M±20%	15	75	2.10	35	25	0.8 ±0.15 (0.031 ±0.006)	4,000
LK-1608-1R0( )TK	1.0	K±10%, M±20%	35	70	0.60	25	10	0.8 ±0.15 (0.031 ±0.006)	4,000
LK-1608-1R2( )TK	1.2	K±10%, M±20%	35	60	0.80	25	10	0.8 ±0.15 (0.031 ±0.006)	4,000
LK-1608-1R5( )TK	1.5	K±10%, M±20%	35	55	0.80	25	10	0.8 ±0.15 (0.031 ±0.006)	4,000
LK-1608-1R8( )TK	1.8	K±10%, M±20%	35	50	0.95	25	10	0.8 ±0.15 (0.031 ±0.006)	4,000
LK-1608-2R2( )TK	2.2	K±10%, M±20%	35	45	1.15	15	10	0.8 ±0.15 (0.031 ±0.006)	4,000
LK-1608-2R7( )TK	2.7	K±10%, M±20%	35	40	1.35	15	10	0.8 ±0.15 (0.031 ±0.006)	4,000
LK-1608-3R3( )TK	3.3	K±10%, M±20%	35	38	1.55	15	10	0.8 ±0.15 (0.031 ±0.006)	4,000
LK-1608-3R9( )TK	3.9	K±10%, M±20%	35	36	1.70	15	10	0.8 ±0.15 (0.031 ±0.006)	4,000
LK-1608-4R7( )TK	4.7	K±10%, M±20%	35	33	2.10	15	10	0.8 ±0.15 (0.031 ±0.006)	4,000
LK-1608-5R6( )TK	5.6	K±10%, M±20%	35	22	1.55	5	4	0.8 ±0.15 (0.031 ±0.006)	4,000
LK-1608-6R8( )TK	6.8	K±10%, M±20%	35	20	1.70	5	4	0.8 ±0.15 (0.031 ±0.006)	4,000
LK-1608-8R2( )TK	8.2	K±10%, M±20%	35	18	2.10	5	4	0.8 ±0.15 (0.031 ±0.006)	4,000
LK-1608-100( )TK	10	K±10%, M±20%	35	17	2.55	5	2	0.8 ±0.15 (0.031 ±0.006)	4,000
LK-1608-120( )TK	12	K±10%, M±20%	35	15	2.75	5	2	0.8 ±0.15 (0.031 ±0.006)	4,000
LK-1608-150MTK	15	±20%	20	14	1.70	1	1	0.8 ±0.15 (0.031 ±0.006)	4,000
LK-1608-180MTK	18	±20%	20	13	1.85	1	1	0.8 ±0.15 (0.031 ±0.006)	4,000
LK-1608-220MTK	22	±20%	20	11	2.10	1	1	0.8 ±0.15 (0.031 ±0.006)	4,000
LK-1608-270MTK	27	±20%	20	10	2.75	1	1	0.8 ±0.15 (0.031 ±0.006)	4,000
LK-1608-330MTK	33	±20%	20	9	2.95	1	1	0.8 ±0.15 (0.031 ±0.006)	4,000

( ) - Insert Inductance Tolerance Code (K or M)



### 0805 Case Size Multilayer Chip Inductors (LK 2125 Series)

Ordering Code	Inductance (μH)	Inductance Tolerance	Q min.	Minimum Self Resonant Frequency (MHz)	Maximum DC Resistance (Ω)	Maximum Rated Current (mA)	Measuring Frequency (MHz)	Thickness mm (inches)	Tape & Reel Packaging Quantity
LK-2125-47NMTK	0.047	±20%	15	320	0.20	300	50	0.85 ±0.2 (0.033 ±0.008)	4,000
LK-2125-68NMTK	0.068	±20%	15	280	0.20	300	50	0.85 ±0.2 (0.033 ±0.008)	4,000
LK-2125-82NMTK	0.082	±20%	15	255	0.20	300	50	0.85 ±0.2 (0.033 ±0.008)	4,000
LK-2125-R10( )TK	0.10	K±10%, M±20%	20	235	0.30	250	25	0.85 ±0.2 (0.033 ±0.008)	4,000
LK-2125-R12( )TK	0.12	K±10%, M±20%	20	220	0.30	250	25	0.85 ±0.2 (0.033 ±0.008)	4,000
LK-2125-R15( )TK	0.15	K±10%, M±20%	20	200	0.40	250	25	0.85 ±0.2 (0.033 ±0.008)	4,000
LK-2125-R18( )TK	0.18	K±10%, M±20%	20	185	0.40	250	25	0.85 ±0.2 (0.033 ±0.008)	4,000
LK-2125-R22( )TK	0.22	K±10%, M±20%	20	170	0.50	250	25	0.85 ±0.2 (0.033 ±0.008)	4,000
LK-2125-R27( )TK	0.27	K±10%, M±20%	20	150	0.50	250	25	0.85 ±0.2 (0.033 ±0.008)	4,000
LK-2125-R33( )TK	0.33	K±10%, M±20%	20	145	0.55	250	25	0.85 ±0.2 (0.033 ±0.008)	4,000
LK-2125-R39( )TK	0.39	K±10%, M±20%	25	135	0.65	200	25	0.85 ±0.2 (0.033 ±0.008)	4,000
LK-2125-R47( )TK	0.47	K±10%, M±20%	25	125	0.65	200	25	1.25 ±0.2 (0.049 ±0.008)	2,000
LK-2125-R56( )TK	0.56	K±10%, M±20%	25	115	0.75	150	25	1.25 ±0.2 (0.049 ±0.008)	2,000
LK-2125-R68( )TK	0.68	K±10%, M±20%	25	105	0.80	150	25	1.25 ±0.2 (0.049 ±0.008)	2,000
LK-2125-R82( )TK	0.82	K±10%, M±20%	25	100	1.00	150	25	1.25 ±0.2 (0.049 ±0.008)	2,000
LK-2125-1R0( )TK	1.0	K±10%, M±20%	45	75	0.40	50	10	0.85 ±0.2 (0.033 ±0.008)	4,000
LK-2125-1R2( )TK	1.2	K±10%, M±20%	45	65	0.50	50	10	0.85 ±0.2 (0.033 ±0.008)	4,000
LK-2125-1R5( )TK	1.5	K±10%, M±20%	45	60	0.50	50	10	0.85 ±0.2 (0.033 ±0.008)	4,000
LK-2125-1R8( )TK	1.8	K±10%, M±20%	45	55	0.60	50	10	0.85 ±0.2 (0.033 ±0.008)	4,000
LK-2125-2R2( )TK	2.2	K±10%, M±20%	45	50	0.65	30	10	0.85 ±0.2 (0.033 ±0.008)	4,000
LK-2125-2R7( )TK	2.7	K±10%, M±20%	45	45	0.75	30	10	1.25 ±0.2 (0.049 ±0.008)	2,000
LK-2125-3R3( )TK	3.3	K±10%, M±20%	45	41	0.80	30	10	1.25 ±0.2 (0.049 ±0.008)	2,000
LK-2125-3R9( )TK	3.9	K±10%, M±20%	45	38	0.90	30	10	1.25 ±0.2 (0.049 ±0.008)	2,000
LK-2125-4R7( )TK	4.7	K±10%, M±20%	45	35	1.00	30	10	1.25 ±0.2 (0.049 ±0.008)	2,000
LK-2125-5R6( )TK	5.6	K±10%, M±20%	50	32	0.90	15	4	1.25 ±0.2 (0.049 ±0.008)	2,000
LK-2125-6R8( )TK	6.8	K±10%, M±20%	50	29	1.00	15	4	1.25 ±0.2 (0.049 ±0.008)	2,000
LK-2125-8R2( )TK	8.2	K±10%, M±20%	50	26	1.10	15	4	1.25 ±0.2 (0.049 ±0.008)	2,000
LK-2125-100( )TK	10	K±10%, M±20%	50	24	1.15	15	2	1.25 ±0.2 (0.049 ±0.008)	2,000
LK-2125-120( )TK	12	K±10%, M±20%	50	22	1.25	15	2	1.25 ±0.2 (0.049 ±0.008)	2,000
LK2-125-150MTK	15	±20%	30	19	0.80	5	1	1.25 ±0.2 (0.049 ±0.008)	2,000
LK-2125-180MTK	18	±20%	30	18	0.90	5	1	1.25 ±0.2 (0.049 ±0.008)	2,000
LK-2125-220MTK	22	±20%	30	16	1.10	5	1	1.25 ±0.2 (0.049 ±0.008)	2,000
LK-2125-270MTK	27	±20%	30	14	1.15	5	1	1.25 ±0.2 (0.049 ±0.008)	2,000
LK-2125-330MTK	33	±20%	30	13	1.25	5	0.4	1.25 ±0.2 (0.049 ±0.008)	2,000

( ) Insert Tolerance Code (K±10% or M±20%) listed to the right



### 0603 Case Size Multilayer Chip Inductors (CK 1608 Series)

Ordering Code	Inductance (μH)	Inductance Tolerance	Minimum Inductance at 200mA (μH)	Maximum DC Resistance (Ω)	Maximum Rated Current (mA)	Measuring Frequency (MHz)	Thickness mm (inches)	Tape & Reel Packaging Quantity
CK-1608-4R7MTK	4.7	±20%	20	0.45	60	4	0.80 ±0.15 (0.031 ±0.006)	4,000
CK-1608-100MTK	10.0	±20%	20	0.85	50	2	0.80 ±0.15 (0.031 ±0.006)	4,000

### 0805 Case Size Multilayer Chip Inductors (CK 2125 Series)

Ordering Code	Inductance (μH)	Inductance Tolerance	Q min.	Minimum Self Resonant Frequency (MHz)	Maximum DC Resistance (Ω)	Maximum Rated Current (mA)	Measuring Frequency (MHz)	Thickness mm (inches)	Tape & Reel Packaging Quantity
CK-2125-R10MTK	0.10	±20%	15	235	0.16	500	25	0.85 ±0.2 (0.033 ±0.008)	4,000
CK-2125-R15MTK	0.15	±20%	15	200	0.20	500	25	0.85 ±0.2 (0.033 ±0.008)	4,000
CK-2125-R22MTK	0.22	±20%	15	170	0.23	400	25	0.85 ±0.2 (0.033 ±0.008)	4,000
CK-2125-R33MTK	0.33	±20%	15	145	0.28	400	25	0.85 ±0.2 (0.033 ±0.008)	4,000
CK-2125-R47MTK	0.47	±20%	15	125	0.32	400	25	1.25 ±0.2 (0.049 ±0.008)	2,000
CK-2125-R68MTK	0.68	±20%	15	105	0.45	300	25	1.25 ±0.2 (0.049 ±0.008)	2,000
CK-2125-1R0MTK	1.0	±20%	20	75	0.26	220	10	0.85 ±0.2 (0.033 ±0.008)	4,000
CK-2125-1R5MTK	1.5	±20%	20	60	0.28	170	10	0.85 ±0.2 (0.033 ±0.008)	4,000
CK-2125-2R2MTK	2.2	±20%	20	50	0.35	150	10	0.85 ±0.2 (0.033 ±0.008)	4,000
CK-2125-3R3MTK	3.3	±20%	20	41	0.43	130	10	1.25 ±0.2 (0.049 ±0.008)	2,000
CK-2125-4R7MTK	4.7	±20%	20	35	0.48	80	10	1.25 ±0.2 (0.049 ±0.008)	2,000
CK-2125-6R8MTK	6.8	±20%	20	29	0.52	70	4	1.25 ±0.2 (0.049 ±0.008)	2,000
CK-2125-100MTK	10.0	±20%	20	24	0.65	60	2	1.25 ±0.2 (0.049 ±0.008)	2,000

### 1206 Case Size Multilayer Chip Inductors (CKP 3216 Series)

Ordering Code	Inductance (μH)	Inductance Tolerance	Minimum Inductance at 200mA (μH)	Maximum DC Resistance (Ω)	Maximum Rated Current (mA)	Measuring Frequency (MHz)	Thickness mm (inches)	Tape & Reel Packaging Quantity
CKP3216-1R0MTK	1.0	±20%	0.5	0.11	1100	1	0.80 ±0.15 (0.031 ±0.006)	4,000
CKP3216-1R5MTK	1.5	±20%	0.8	0.13	1000	1	0.80 ±0.15 (0.031 ±0.006)	4,000
CKP3216-2R2MTK	2.2	±20%	1.1	0.14	900	1	0.80 ±0.15 (0.031 ±0.006)	4,000
CKP3216-3R3MTK	3.3	±20%	1.4	0.16	800	1	0.80 ±0.15 (0.031 ±0.006)	4,000
CKP3210-4R7MTK	4.7	±20%	1.9	0.20	700	1	0.80 ±0.15 (0.031 ±0.006)	4,000

## Low Profile SMD Inductors (NR Series)

### Features:

- Small and low profile inductor
- Corresponds to high current
- Simple and original magnetic shield structure
- Structure strong against shock-proof

### Applications:

- For small DC/DC converter; cellular phones, HDD, HVC, DSC, and PDA LCD display

### Operating Temperature:

- -25°C to +120°C (including self-generated heat)

### Part Numbering Table

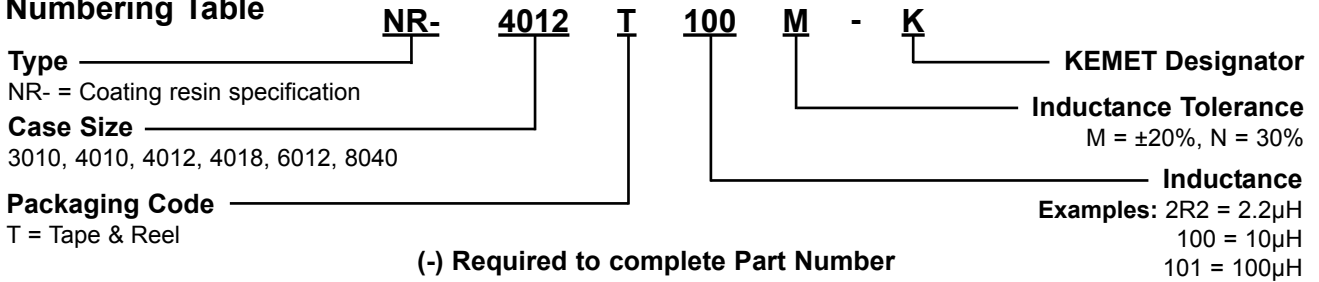

### Dimension Table in millimeters (inches)

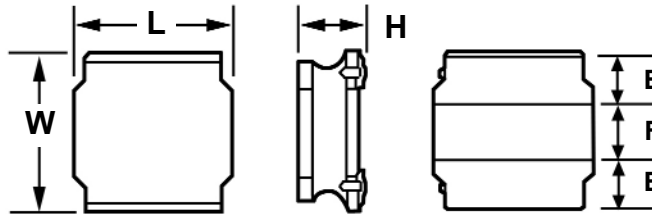

Dim. Code	L Length (inches)	W Width (inches)	T Thickness Maximum (inches)	E (inches)	F
3010	3.0 ±0.1 (0.118 ±0.004)	3.0 ±0.1 (0.118 ±0.004)	1.0 max. (0.039 max.)	0.9 ±0.2 (0.035 ±0.008)	1.9 ±0.2 (0.075 ±0.008)
4010	4.0 ±0.2 (0.157 ±0.008)	4.0 ±0.2 (0.157 ±0.008)	1.0 max. (0.039 max.)	1.1 ±0.2 (0.043 ±0.008)	2.5 ±0.2 (0.098 ±0.008)
4012	4.0 ±0.2 (0.157 ±0.008)	4.0 ±0.2 (0.157 ±0.008)	1.2 max. (0.047 max.)	1.1 ±0.2 (0.043 ±0.008)	2.5 ±0.2 (0.098 ±0.008)
4018	4.0 ±0.2 (0.157 ±0.008)	4.0 ±0.2 (0.157 ±0.008)	1.2 max. (0.047 max.)	1.1 ±0.2 (0.043 ±0.008)	2.5 ±0.2 (0.098 ±0.008)
6012	6.0 ±0.2 (0.236 ±0.008)	6.0 ±0.2 (0.236 ±0.008)	1.2 max. (0.047 max.)	1.0 ±0.2 (0.039 ±0.008)	4.8 ±0.2 (0.189 ±0.008)
8040	8.0 ±0.2 (0.315 ±0.008)	8.0 ±0.2 (0.315 ±0.008)	4.2 max (0.165 max)	1.6 ±0.3 (0.063 ±0.012)	5.6 ±0.3 (0.220 ±0.012)

### Dimensions 3.0mm x 3.0mm (NR3010 Type, 1.0mm Max. Height)

Ordering code	Inductance (µH)	Inductance Tolerance	Measuring Frequency (KHz)	Minimum Self-resonant Frequency (MHz)	Maximum DC Resistance (Ω) ±30%	Maximum Rated Current (mA)	Maximum Height (mm)	Tape & Reel Packaging Quantity
NR-3010T1R0N-K	1.0	±30%	100	126	0.065	1300	1.0	2,000
NR-3010T1R5N-K	1.5	±30%	100	98	0.08	1200	1.0	2,000
NR-3010T2R2M-K	2.2	±20%	100	82	0.095	1100	1.0	2,000
NR-3010T3R3M-K	3.3	±20%	100	63	0.14	870	1.0	2,000
NR-3010T4R7M-K	4.7	±20%	100	56	0.19	750	1.0	2,000
NR-3010T6R8M-K	6.8	±20%	100	46	0.30	610	1.0	2,000
NR-3010T100M-K	10	±20%	100	35	0.45	500	1.0	2,000
NR-3010T150M-K	15	±20%	100	30	0.74	400	1.0	2,000
NR-3010T220M-K	22	±20%	100	25	1.03	350	1.0	2,000
NR-3010T330M-K	33	±20%	100	20	1.55	260	1.0	2,000
NR-3010T470M-K	47	±20%	100	17	2.05	220	1.0	2,000

### Dimensions 4.0mm x 4.0mm (NR4010 Type, 1.0mm Max. Height)

Ordering code	Inductance (µH)	Inductance Tolerance	Measuring Frequency (KHz)	Minimum Self-resonant Frequency (MHz)	Maximum DC Resistance (Ω) ±30%	Maximum Rated Current (mA)	Maximum Height (mm)	Tape & Reel Packaging Quantity
NR-4010T1R0N-K	1.0	±30%	100	116	0.10	1050	1.0	5,000
NR-4010T2R2M-K	2.2	±30%	100	73	0.15	890	1.0	5,000
NR-4010T3R3M-K	3.3	±20%	100	58	0.18	820	1.0	5,000
NR-4010T4R7M-K	4.7	±20%	100	47	0.21	750	1.0	5,000
NR-4010T6R8M-K	6.8	±20%	100	38	0.30	620	1.0	5,000
NR-4010T100M-K	10	±20%	100	31	0.38	560	1.0	5,000
NR-4010T150M-K	15	±20%	100	24	0.51	470	1.0	5,000
NR-4010T220M-K	22	±20%	100	19	0.87	360	1.0	5,000
NR-4010T330M-K	33	±20%	100	15	1.54	280	1.0	5,000
NR-4010T470M-K	47	±20%	100	13	1.81	240	1.0	5,000



### Dimensions 4.0mm x 4.0mm (NR4012 Type, 1.2mm Max. Height)

Ordering code	Inductance (μH)	Inductance Tolerance	Measuring Frequency (KHz)	Minimum Self-resonant Frequency (MHz)	Maximum DC Resistance (Ω) ±30%	Maximum Rated Current (mA)	Maximum Height (mm)	Tape & Reel Packaging Quantity
NR-4012T2R2M-K	2.2	±20%	100	66	0.09	1200	1.2	4,500
NR-4012T3R3M-K	3.3	±20%	100	50	0.13	980	1.2	4,500
NR-4012T4R7M-K	4.7	±20%	100	45	0.14	960	1.2	4,500
NR-4012T6R8M-K	6.8	±20%	100	35	0.18	840	1.2	4,500
NR-4012T100M-K	10	±20%	100	28	0.24	740	1.2	4,500
NR-4012T150M-K	15	±20%	100	23	0.40	560	1.2	4,500
NR-4012T-220M-K	22	±20%	100	18	0.48	510	1.2	4,500
NR-4012T330M-K	33	±20%	100	15	0.81	400	1.2	4,500
NR-4012T470M-K	47	±20%	100	12	1.00	350	1.2	4,500

### Dimensions 4.0mm x 4.0mm (NR4018 Type, 1.8mm Max. Height)

Ordering code	Inductance (μH)	Inductance Tolerance	Measuring Frequency (KHz)	Minimum Self-resonant Frequency (MHz)	Maximum DC Resistance (Ω) ±30%	Maximum Rated Current (mA)	Maximum Height (mm)	Tape & Reel Packaging Quantity
NR-4018T1R0N-K	1.0	±30%	100	80	0.03	1830	1.8	3,500
NR-4018T2R2M-K	2.2	±20%	100	52	0.06	1440	1.8	3,500
NR-4018T3R3M-K	3.3	±20%	100	44	0.07	1230	1.8	3,500
NR-4018T4R7M-K	4.7	±20%	100	34	0.09	1200	1.8	3,500
NR-4018T6R8M-K	6.8	±20%	100	29	0.11	1060	1.8	3,500
NR-4018T100M-K	10	±20%	100	24	0.18	840	1.8	3,500
NR-4018T150M-K	15	±20%	100	19	0.25	650	1.8	3,500
NR-4018T220M-K	22	±20%	100	16	0.36	590	1.8	3,500
NR-4018T330M-K	33	±20%	100	12	0.53	490	1.8	3,500
NR-4018T470M-K	47	±20%	100	10	0.65	420	1.8	3,500
NR-4018T680M-K	68	±20%	100	8.3	1.00	320	1.8	3,500
NR-4018T101M-K	100	±20%	100	6.5	1.50	280	1.8	3,500
NR-4018T221M-K	200	±20%	100	4	4.00	170	1.8	3,500

### Dimensions 6.0mm x 6.0mm (NR6012 Type, 1.2mm Max. Height)

Ordering code	Inductance (μH)	Inductance Tolerance	Measuring Frequency (KHz)	Minimum Self-resonant Frequency (MHz)	Maximum DC Resistance (Ω) ±30%	Maximum Rated Current (mA)	Maximum Height (mm)	Tape & Reel Packaging Quantity
NR-6012T3R0M-K	3.0	±20%	100	45	0.092	1730	1.2	1,000
NR-6012T4R0M-K	4.0	±20%	100	39	0.107	1570	1.2	1,000
NR-6012T5R3M-K	5.3	±20%	100	34	0.125	1400	1.2	1,000
NR-6012T6R8M-K	6.8	±20%	100	30	0.165	1180	1.2	1,000
NR-6012T100M-K	10	±20%	100	22	0.24	1000	1.2	1,000
NR-6012T150M-K	15	±20%	100	18	0.33	790	1.2	1,000
NR-6012T220M-K	22	±20%	100	12	0.55	630	1.2	1,000
NR-6012T330M-K	33	±20%	100	8	0.71	530	1.2	1,000
NR-6012T470M-K	47	±20%	100	6	1.13	460	1.2	1,000
NR-6012T680M-K	68	±20%	100	3	1.35	410	1.2	1,000
NR-6012T101M-K	100	±20%	100	1	2.18	320	1.2	1,000

### Dimensions 8.0mm x 8.0mm (NR8040 Type, 4.2mm Max. Height)

Ordering code	Inductance (μH)	Inductance Tolerance	Measuring Frequency (KHz)	Minimum Self-resonant Frequency (MHz)	Maximum DC Resistance (Ω) ±30%	Maximum Rated Current (mA)	Maximum Height (mm)	Tape & Reel Packaging Quantity
NR-8040T1R9N-K	0.9	±30%	100	85	0.006	7800	4.2	1,000
NR-8040T1R4N-K	1.4	±30%	100	63	0.007	7000	4.2	1,000
NR-8040T2R0N-K	2.0	±30%	100	50	0.009	6300	4.2	1,000
NR-8040T3R6N-K	3.6	±30%	100	34	0.015	4900	4.2	1,000
NR-8040T4R7N-K	4.7	±30%	100	30	0.018	4100	4.2	1,000
NR-8040T6R8N-K	6.8	±30%	100	24	0.025	3700	4.2	1,000
NR-8040T100N-K	10	±20%	100	22	0.034	3100	4.2	1,000
NR-8040T150N-K	15	±20%	100	16	0.050	2400	4.2	1,000
NR-8040T220N-K	22	±20%	100	13	0.066	2200	4.2	1,000
NR-8040T330N-K	33	±20%	100	12	0.100	1700	4.2	1,000
NR-8040T470N-K	47	±20%	100	8	0.150	1400	4.2	1,000
NR-8040T680N-K	68	±20%	100	7	0.230	1100	4.2	1,000
NR-8040T101N-K	100	±20%	100	6	0.290	1000	4.2	1,000



## High Current Ferrite Chip Beads - FB Series M Type

### Features:

- Power supply units:
  - Large withstand voltage (allowable current up to 6A)
  - Resistant to high energy
  - High reliability
- There are several variations of the standard (FBMJ) type
  - HS for broadband
  - HM for upper MHz range applications
  - HL for GHz range applications
- The FBMH type is optimal for circuit designs which require impedance and large currents to combat radiated noise on power lines, etc.

### Applications:

- Combats power line radiated and conducted noise
- Provides waveform correction of digital signals and high frequency noise countermeasures in various types of digital equipment
- Automotive
- Computer peripherals
- Differential transmission line on USB and similar products
- Mobile devices which require lower power consumption

### Operating Temperature:

- -40°C to +85°C (includes self-generated heat)

## Part Numbering Table

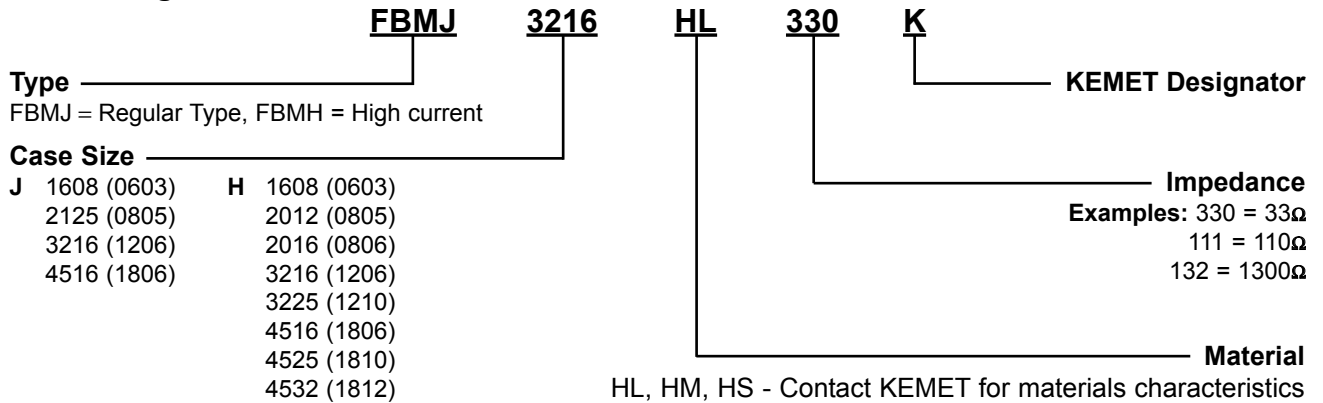

## Dimension Table in millimeters (inches)

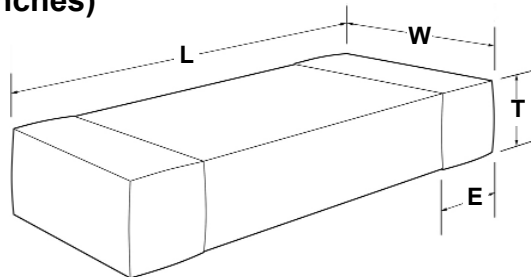

Characteristic Code	Dim. Code	EIA Case Size	L Length (inches)	W Width (inches)	T Thickness Maximum (inches)	E (inches)
J	1608	0603	1.6 ±0.2 (0.063 ±0.008)	0.8 ±0.2 (0.031 ±0.008)	0.8 ±0.2 (0.031 ±0.008)	0.3 ±0.2 (0.012 ±0.008)
	2125	0805	2.0 ±0.2 (0.079 ±0.008)	1.25 ±0.2 (0.049 ±0.008)	0.85 ±0.2 (0.02 ±0.002)	0.5 ±0.3 (0.020 ±0.012)
	3216	1206	3.2 ±0.3 (0.126 ±0.012)	1.6 ±0.2 (0.063 ±0.008)	1.6 ±0.2 (0.063 ±0.008)	0.5 ±0.3 (0.020 ±0.012)
	4516	1806	4.5 ±0.3 (0.177 ±0.012)	1.6 ±0.2 (0.063 ±0.008)	1.6 ±0.2 (0.063 ±0.008)	0.5 ±0.3 (0.020 ±0.012)
H	1608	0603	1.6 ±0.1 (0.063 ±0.004)	0.8 ±0.1 (0.031 ±0.004)	0.8 ±0.1 (0.031 ±0.004)	0.3 ±0.15 (0.012 ±0.006)
	2012	0805	2.0 ±0.2 (0.079 ±0.008)	1.25 ±0.2 (0.049 ±0.008)	0.85 ±0.2 (0.02 ±0.002)	0.5 ±0.3 (0.020 ±0.012)
	2016	0806	2.0 ±0.2 (0.079 ±0.008)	1.6 ±0.2 (0.063 ±0.008)	1.6 ±0.2 (0.063 ±0.008)	0.5 ±0.3 (0.020 ±0.012)
	3216	1206	3.2 ±0.3 (0.126 ±0.012)	1.6 ±0.2 (0.063 ±0.008)	1.6 ±0.2 (0.063 ±0.008)	0.5 ±0.3 (0.020 ±0.012)
	3225	1210	3.2 ±0.3 (0.126 ±0.012)	2.5 ±0.3 (0.098 ±0.012)	2.5 ±0.3 (0.098 ±0.012)	0.5 ±0.3 (0.020 ±0.012)
	4516	1806	4.5 ±0.3 (0.177 ±0.012)	1.6 ±0.2 (0.063 ±0.008)	1.6 ±0.2 (0.063 ±0.008)	0.5 ±0.3 (0.020 ±0.012)
	4525	1810	4.5 ±0.4 (0.177 ±0.016)	2.5 ±0.3 (0.098 ±0.012)	2.5 ±0.3 (0.098 ±0.012)	0.9 ±0.6 (0.035 ±0.024)
	4532	1812	4.5 ±0.4 (0.177 ±0.016)	3.2 ±0.3 (0.126 ±0.012)	3.2 ±0.3 (0.126 ±0.012)	0.9 ±0.6 (0.035 ±0.024)

### 0603 Case Size High Current Ferrite Chip Beads (FB Series M Type)

Ordering Code	Impedance (Ω)	Measuring Frequency (MHz)	Maximum DC Resistance (Ω)	Maximum Rated Current (A)	Thickness mm (inches)	Tape & Reel Packaging Quantity
FBMJ1608HS280K	28 ±30%	100	0.007	4	0.8 ±0.2 (0.031 ±0.008)	4,000
FBMJ1608HM230K	23 ±30%	100	0.007	4	0.8 ±0.2 (0.031 ±0.008)	4,000

### 0805 Case Size High Current Ferrite Chip Beads (FB Series M Type)

Ordering Code	Impedance (Ω)	Measuring Frequency (MHz)	Maximum DC Resistance (Ω)	Maximum Rated Current (A)	Thickness mm (inches)	Tape & Reel Packaging Quantity
FBMJ2125HS420K	42 ±25%	100	0.008	4	0.85 ±0.2 (0.033 ±0.008)	4,000
FBMJ2125HS250K	25 ±30%	100	0.004	6	0.85 ±0.2 (0.033 ±0.008)	4,000
FBMJ2125HM330K	33 ±25%	100	0.008	4	0.85 ±0.2 (0.033 ±0.008)	4,000
FBMJ2125HM210K	21 ±30%	100	0.004	6	0.85 ±0.2 (0.033 ±0.008)	4,000
FBMJ2125HL8R0K	8 ±30%	100	0.01	2	0.85 ±0.2 (0.033 ±0.008)	4,000

### 1206 Case Size High Current Ferrite Chip Beads (FB Series M Type)

Ordering Code	Impedance (Ω)	Measuring Frequency (MHz)	Maximum DC Resistance (Ω)	Maximum Rated Current (A)	Thickness mm (inches)	Tape & Reel Packaging Quantity
FBMJ3216HS800K	80 ±25%	100	0.01	4	1.1 ±0.2 (0.043 ±0.008)	2,000
FBMJ3216HS480K	48 ±30%	100	0.005	6	1.1 ±0.2 (0.043 ±0.008)	2,000
FBMJ3216HM600K	60 ±25%	100	0.01	4	1.1 ±0.2 (0.043 ±0.008)	2,000
FBMJ3216HM380K	38 ±30%	100	0.005	6	1.1 ±0.2 (0.043 ±0.008)	2,000

### 1806 Case Size High Current Ferrite Chip Beads (FB Series M Type)

Ordering Code	Impedance (Ω)	Measuring Frequency (MHz)	Maximum DC Resistance (Ω)	Maximum Rated Current (A)	Thickness mm (inches)	Tape & Reel Packaging Quantity
FBMJ4516HS111K	110 ±25%	100	0.014	4	1.1 ±0.2 (0.043 ±0.008)	2,000
FBMJ4516HS720K	72 ±30%	100	0.007	6	1.1 ±0.2 (0.043 ±0.008)	2,000
FBMJ4516HM900K	90 ±25%	100	0.014	4	1.1 ±0.2 (0.043 ±0.008)	2,000
FBMJ4516HM560K	56 ±30%	100	0.007	6	1.1 ±0.2 (0.043 ±0.008)	2,000





### High Impedance Type Ferrite Chip Beads (FB Series M Type)

Ordering Code	EIA Case Size	Impedance (Ω)	Measuring Frequency (MHz)	Maximum DC Resistance (Ω)	Maximum Rated Current (A)	Thickness mm (inches)	Tape & Reel Packaging Quantity
FBMH1608HM470K	0603	47 ±25%	100	0.02	3.5	0.8 ±0.1 (0.031 ±0.004)	4,000
FBMH1608HM600K	0603	60 ±25%	100	0.025	3	0.8 ±0.1 (0.031 ±0.004)	4,000
FBMH1608HM101K	0603	100 ±25%	100	0.035	2	0.8 ±0.1 (0.031 ±0.004)	4,000
FBMH1608HM151K	0603	150 ±25%	100	0.05	2	0.8 ±0.1 (0.031 ±0.004)	4,000
FBMH1608HM221K	0603	220 ±25%	100	0.07	1.5	0.8 ±0.1 (0.031 ±0.004)	4,000
FBMH1608HM331K	0603	330 ±25%	100	0.13	0.9	0.8 ±0.1 (0.031 ±0.004)	4,000
FBMH1608HM471K	0603	470 ±25%	100	0.15	0.7	0.8 ±0.1 (0.031 ±0.004)	4,000
FBMH1608HM601K	0603	600 ±25%	100	0.17	0.7	0.8 ±0.1 (0.031 ±0.004)	4,000
FBMH1608HM102K	0603	1000 ±25%	100	0.35	0.3	0.8 ±0.1 (0.031 ±0.004)	4,000
FBMH1608HL300K	0603	30 ±25%	100	0.028	2.5	0.8 ±0.1 (0.031 ±0.004)	4,000
FBMH1608HL600K	0603	60 ±25%	100	0.045	1.8	0.8 ±0.1 (0.031 ±0.004)	4,000
FBMH1608HL121K	0603	120 ±25%	100	0.13	0.9	0.8 ±0.1 (0.031 ±0.004)	4,000
FBMH1608HL221K	0603	220 ±25%	100	0.17	0.7	0.8 ±0.1 (0.031 ±0.004)	4,000
FBMH1608HL331K	0603	330 ± 5%	100	0.21	0.6	0.8 ±0.1 (0.031 ±0.004)	4,000
FBMH1608HL471K	0603	470 ±25%	100	0.35	0.5	0.8 ±0.1 (0.031 ±0.004)	4,000
FBMH1608HL601K	0603	600 ±25%	100	0.45	0.4	0.8 ±0.1 (0.031 ±0.004)	4,000
FBMH2012HM800K	0805	80 ±25%	100	0.025	2.7	0.85 ±0.2 (0.033 ±0.008)	4,000
FBMH2012HM121K	0805	120 ±25%	100	0.032	2.5	0.85 ±0.2 (0.033 ±0.008)	4,000
FBMH2012HM221K	0805	220 ±25%	100	0.06	2	0.85 ±0.2 (0.033 ±0.008)	4,000
FBMH2012HM331K	0805	330 ±25%	100	0.08	1.8	0.85 ±0.2 (0.033 ±0.008)	4,000
FBMH2016HM251K	0806	250 ±30%	100	0.05	2	1.6 ±0.2 (0.063 ±0.008)	2,000
FBMH3216HM501K	1206	500 ±30%	100	0.07	2	1.6 ±0.2 (0.063 ±0.008)	2,000
FBMH4516HM851K	1806	850 ±30%	100	0.1	1.5	1.6 ±0.2 (0.063 ±0.008)	2,000
FBMH3225HM601K	1210	600 ±30%	100	0.042	3	2.5 ±0.3 (0.098 ±0.012)	1,000
FBMH3225HM102K	1210	1000 ±30%	100	0.1	2	2.5 ±0.3 (0.098 ±0.012)	1,000
FBMH3225HM202K	1210	2000 ±30%	100	0.13	1.2	2.5 ±0.3 (0.098 ±0.012)	1,000
FBMH4525HM102K	1810	1000 ±30%	100	0.06	3	2.5 ±0.3 (0.098 ±0.012)	1,000
FBMH4525HM162K	1810	1600 ±30%	100	0.13	2	2.5 ±0.3 (0.098 ±0.012)	1,000
FBMH4532HM681K	1812	680 ±25%	100	0.028	4	3.2 ±0.3 (0.126 ±0.012)	2,000
FBMH4532HM132K	1812	1300 ±25%	100	0.06	3	3.2 ±0.3 (0.126 ±0.012)	2,000
FBMH4532HM202K	1812	2000 ±25%	100	0.13	1.3	3.2 ±0.3 (0.126 ±0.012)	2,000

## Multilayer Ferrite Chip Beads - BK Series

### BK Features:

- Internal silver printed layer creates a closed circuit which acts as a magnetic shield to minimize heat generation and crosstalk
  - No need for grounding provides greater circuit design flexibility
  - Several material types and a broad range of impedance values provide noise countermeasures for various applications
- HS: Suppresses the XL component. Helps stop the reduction of the wave-form integrity (digital wave-form overshoot, etc)
- HM: Increases the Z characteristics sharply above 20MHz and is applicable for radiated noise in the 100MHz-300MHz range. Especially effective on video signal lines.
- LL: Designed as a noise countermeasure for 200MHz-500MHz range where the rise of the Z component is in the high frequency area.
- LM: Intended for noise suppression around 200MHz. Effectively increase attenuation
- HW: The best material in the BK Series to suppress the XL component and stop the reduction of the wave-form integrity while maintaining attenuation in the high frequency area.
- TS: Reduced DC resistance version for noise countermeasures around LSI power supplies

### BKP Features:

- Low Rdc values reduce power dissipation and extend battery life
- No need for grounding provides greater circuit design flexibility

### BK Applications:

- High frequency noise countermeasure in personal computers, digital cameras and other information system products. For use on digital product clock lines and general signal lines.
- Radiated noise suppression in computer or printer interfaces harness connectors.
- Noise suppression in video and other AV products
- Prevents interference between circuits in cellular phones (PHS, PDC, etc)
- Due to the closed internal circuit which acts as a magnetic shield, the TS material is extremely effective as a noise filter on LSI power supplies where downsizing of components is needed.

### BKP Applications:

- High frequency noise countermeasures on the DC power supply line in personal computers and other information system products
- Noise suppression in USB and IEEE1294 interface
- Prevents interference between circuits in mobile systems (PDC, PHS, PDA)

### Operating Temperature:

- BK: -55°C to +125°C (includes self-generated heat)
- BKP: -55°C to +85°C (includes sel-generated heat)

## Part Numbering Table

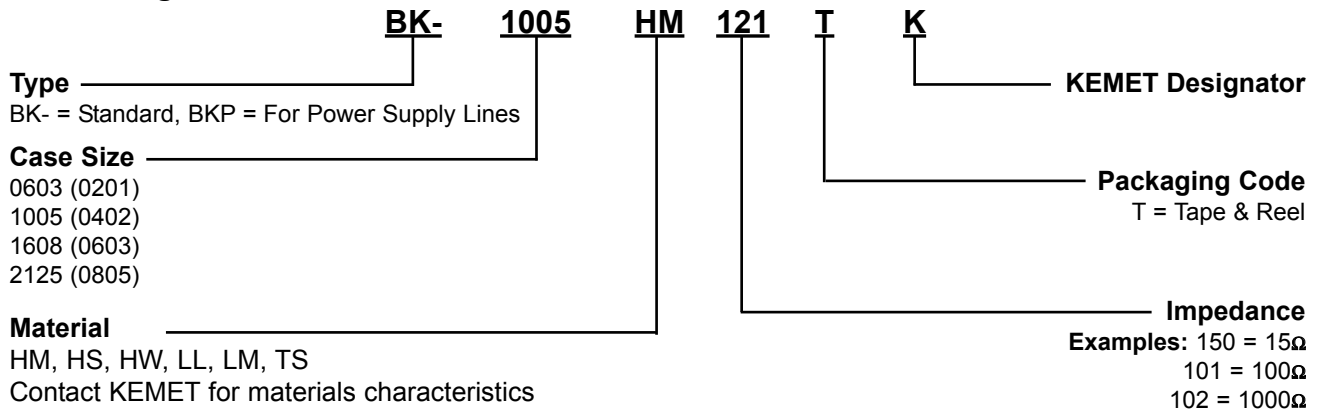

## Dimension Table in millimeters (inches)

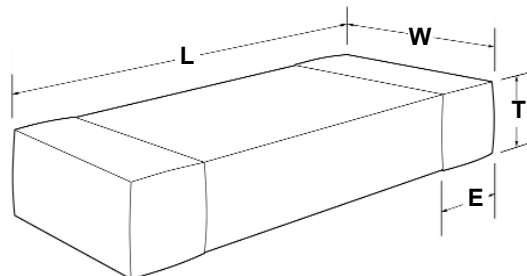

Dim. Code	EIA Case Size	L Length (inches)	W Width (inches)	T Thickness Maximum (inches)	E (inches)
0603	0201	1.6 ±0.2 (0.063 ±0.008)	0.8 ±0.2 (0.031 ±0.008)	0.8 ±0.2 (0.031 ±0.008)	0.3 ±0.2 (0.012 ±0.008)
1005	0402	1.00 ±0.05 (0.039 ±0.002)	0.50 ±0.05 (0.020 ±0.002)	0.50 ±0.05 (0.020 ±0.002)	0.25 ±0.10 (0.010 ±0.004)
1608	0603	1.6 ±0.15 (0.063 ±0.006)	0.8 ±0.15 (0.031 ±0.006)	0.8 ±0.15 (0.031 ±0.006)	0.3 ±0.2 (0.012 ±0.008)
2125	0805	2.0 +0.3/-0.1 (0.079 +0.012/-0.004)	1.25 ±0.2 (0.049 ±0.008)	0.85 ±0.2 (0.033 ±0.008)	0.5 ±0.3 (0.020 ±0.012)



### 0201 Multilayer Ferrite Chip Beads Standard Type (BK Series)

Ordering Code	Impedance (Ω) ±25%	Measuring Frequency (MHz)	Maximum DC Resistance (Ω)	Maximum Rated Current (mA)	Thickness mm (inches)	Tape & Reel Packaging Quantity
BK-0603HS220TK	22	100	0.10	500	0.30 ±0.03 (0.012 ±0.001)	15,000
BK-0603HS330TK	33	100	0.20	350	0.30 ±0.03 (0.012 ±0.001)	15,000
BK-0603HS800TK	80	100	0.40	200	0.30 ±0.03 (0.012 ±0.001)	15,000
BK-0603HS121TK	120	100	0.50	200	0.30 ±0.03 (0.012 ±0.001)	15,000
BK-0603HS241TK	240	100	0.80	200	0.30 ±0.03 (0.012 ±0.001)	15,000
BK-0603HM600TK	60	100	0.40	200	0.30 ±0.03 (0.012 ±0.001)	15,000
BK-0603HM121TK	120	100	0.50	200	0.30 ±0.03 (0.012 ±0.001)	15,000
BK-0603HM241TK	240	100	0.80	200	0.30 ±0.03 (0.012 ±0.001)	15,000
BK-0603LL100TK	10	100	0.40	200	0.30 ±0.03 (0.012 ±0.001)	15,000
BK-0603LL220TK	22	100	0.50	200	0.30 ±0.03 (0.012 ±0.001)	15,000
BK-0603LL330TK	33	100	0.80	150	0.30 ±0.03 (0.012 ±0.001)	15,000
BK-0603LL470TK	47	100	1.00	150	0.30 ±0.03 (0.012 ±0.001)	15,000

### 0402 Multilayer Ferrite Chip Beads Standard Type (BK Series)

Ordering Code	Impedance (Ω) ±25%	Measuring Frequency (MHz)	Maximum DC Resistance (Ω)	Maximum Rated Current (mA)	Thickness mm (inches)	Tape & Reel Packaging Quantity
BK-1005HW680TK	68	100	0.17	500	0.50 ±0.05 (0.020 ±0.002)	10,000
BK-1005HW121TK	120	100	0.24	450	0.50 ±0.05 (0.020 ±0.002)	10,000
BK-1005HW241TK	240	100	0.31	400	0.50 ±0.05 (0.020 ±0.002)	10,000
BK-1005HW431TK	430	100	0.50	350	0.50 ±0.05 (0.020 ±0.002)	10,000
BK-1005HW601TK	600	100	0.60	300	0.50 ±0.05 (0.020 ±0.002)	10,000
BK-1005HS100TK	10	100	0.05	1000	0.50 ±0.05 (0.020 ±0.002)	10,000
BK-1005HS330TK	33	100	0.10	700	0.50 ±0.05 (0.020 ±0.002)	10,000
BK-1005HS680TK	68	100	0.13	600	0.50 ±0.05 (0.020 ±0.002)	10,000
BK-1005HS121TK	120	100	0.23	500	0.50 ±0.05 (0.020 ±0.002)	10,000
BK-1005HS241TK	240	100	0.33	400	0.50 ±0.05 (0.020 ±0.002)	10,000
BK-1005HS601TK	600	100	0.58	300	0.50 ±0.05 (0.020 ±0.002)	10,000
BK-1005HM121TK	120	100	0.25	300	0.50 ±0.05 (0.020 ±0.002)	10,000
BK-1005HM241TK	240	100	0.36	300	0.50 ±0.05 (0.020 ±0.002)	10,000
BK-1005HM471TK	470	100	0.56	250	0.50 ±0.05 (0.020 ±0.002)	10,000
BK-1005HM601TK	600	100	0.59	250	0.50 ±0.05 (0.020 ±0.002)	10,000
BK-1005HM102TK	1000	100	0.80	150	0.50 ±0.05 (0.020 ±0.002)	10,000
BK-1005LL100TK	10	100	0.15	500	0.50 ±0.05 (0.020 ±0.002)	10,000
BK-1005LL220TK	22	100	0.20	400	0.50 ±0.05 (0.020 ±0.002)	10,000
BK-1005LL330TK	33	100	0.30	400	0.50 ±0.05 (0.020 ±0.002)	10,000
BK-1005LL470TK	47	100	0.35	350	0.50 ±0.05 (0.020 ±0.002)	10,000
BK-1005LL680TK	68	100	0.31	400	0.50 ±0.05 (0.020 ±0.002)	10,000
BK-1005LL121TK	120	100	0.45	350	0.50 ±0.05 (0.020 ±0.002)	10,000
BK-1005LL181TK	180	100	0.53	300	0.50 ±0.05 (0.020 ±0.002)	10,000
BK-1005LL241TK	240	100	0.70	250	0.50 ±0.05 (0.020 ±0.002)	10,000

### 0402 Multilayer Ferrite Chip Beads For Power Lines (BKP Series)

Ordering Code	Impedance (Ω) ±25%	Measuring Frequency (MHz)	Maximum DC Resistance (Ω)	Maximum Rated Current (mA)	Thickness mm (inches)	Tape & Reel Packaging Quantity
BKP1005HS121TK	120	100	0.14	1000	0.50 ±0.05 (0.020 ±0.002)	10,000



### 0603 Multilayer Ferrite Chip Beads Standard Type (BK Series)

Ordering Code	Impedance (Ω) ±25%	Measuring Frequency (MHz)	Maximum DC Resistance (Ω)	Maximum Rated Current (mA)	Thickness mm (inches)	Tape & Reel Packaging Quantity
BK-1608HW121TK	120	100	0.15	600	0.80 ±0.15 (0.031 ±0.006)	4,000
BK-1608HW241TK	240	100	0.25	450	0.80 ±0.15 (0.031 ±0.006)	4,000
BK-1608HW431TK	430	100	0.30	400	0.80 ±0.15 (0.031 ±0.006)	4,000
BK-1608HW601TK	600	100	0.40	300	0.80 ±0.15 (0.031 ±0.006)	4,000
BK-1608HS220TK	22	100	0.05	1500	0.80 ±0.15 (0.031 ±0.006)	4,000
BK-1608HS330TK	33	100	0.08	1200	0.80 ±0.15 (0.031 ±0.006)	4,000
BK-1608HS470TK	47	100	0.10	900	0.80 ±0.15 (0.031 ±0.006)	4,000
BK-1608HS600TK	60	100	0.10	800	0.80 ±0.15 (0.031 ±0.006)	4,000
BK-1608HS800TK	80	100	0.10	600	0.80 ±0.15 (0.031 ±0.006)	4,000
BK-1608HS121TK	120	100	0.18	500	0.80 ±0.15 (0.031 ±0.006)	4,000
BK-1608HS241TK	240	100	0.25	400	0.80 ±0.15 (0.031 ±0.006)	4,000
BK-1608HS601TK	600	100	0.45	350	0.80 ±0.15 (0.031 ±0.006)	4,000
BK-1608HS102TK	1000	100	0.60	300	0.80 ±0.15 (0.031 ±0.006)	4,000
BK-1608HM121TK	120	100	0.20	350	0.80 ±0.15 (0.031 ±0.006)	4,000
BK-1608HM241TK	240	100	0.35	300	0.80 ±0.15 (0.031 ±0.006)	4,000
BK-1608HM471TK	470	100	0.45	250	0.80 ±0.15 (0.031 ±0.006)	4,000
BK-1608HM601TK	600	100	0.60	250	0.80 ±0.15 (0.031 ±0.006)	4,000
BK-1608HM102TK	1000	100	0.70	200	0.80 ±0.15 (0.031 ±0.006)	4,000
BK-1608LL300TK	30	100	0.20	500	0.80 ±0.15 (0.031 ±0.006)	4,000
BK-1608LL470TK	47	100	0.30	400	0.80 ±0.15 (0.031 ±0.006)	4,000
BK-1608LL560TK	56	100	0.30	400	0.80 ±0.15 (0.031 ±0.006)	4,000
BK-1608LL680TK	68	100	0.35	300	0.80 ±0.15 (0.031 ±0.006)	4,000
BK-1608LL121TK	120	100	0.50	300	0.80 ±0.15 (0.031 ±0.006)	4,000
BK-1608LL181TK	180	100	0.65	250	0.80 ±0.15 (0.031 ±0.006)	4,000
BK-1608LL241TK	240	100	0.80	250	0.80 ±0.15 (0.031 ±0.006)	4,000
BK-1608LL331TK	330	100	0.85	200	0.80 ±0.15 (0.031 ±0.006)	4,000
BK-1608LL431TK	430	100	0.85	200	0.80 ±0.15 (0.031 ±0.006)	4,000
BK-1608LL511TK	510	100	0.90	200	0.80 ±0.15 (0.031 ±0.006)	4,000
BK-1608LL681TK	680	100	1.00	150	0.80 ±0.15 (0.031 ±0.006)	4,000
BK-1608LM751TK	750	100	0.60	300	0.80 ±0.15 (0.031 ±0.006)	4,000
BK-1608LM152TK	1500	100	0.75	250	0.80 ±0.15 (0.031 ±0.006)	4,000
BK-1608LM182TK	1800	100	0.85	200	0.80 ±0.15 (0.031 ±0.006)	4,000
BK-1608LM252TK	2500	100	1.10	200	0.80 ±0.15 (0.031 ±0.006)	4,000
BK-1608TS431TK	430	100	0.25 ±30%	400	0.80 ±0.15 (0.031 ±0.006)	4,000
BK-1608TS601TK	600	100	0.27 ±30%	350	0.80 ±0.15 (0.031 ±0.006)	4,000
BK-1608TS102TK	1000	100	0.35 ±30%	300	0.80 ±0.15 (0.031 ±0.006)	4,000

### 0603 Multilayer Ferrite Chip Beads For Power Lines (BKP Series)

Ordering Code	Impedance (Ω) ±25%	Measuring Frequency (MHz)	Maximum DC Resistance (Ω)	Maximum Rated Current (mA)	Thickness mm (inches)	Tape & Reel Packaging Quantity
BKP1608HS330TK	33	100	0.025	3000	0.80 ±0.15 (0.031 ±0.006)	4,000
BKP1608HS600TK	60	100	0.040	2500	0.80 ±0.15 (0.031 ±0.006)	4,000
BKP1608HS101TK	100	100	0.050	1700	0.80 ±0.15 (0.031 ±0.006)	4,000
BKP1608HS121TK	120	100	0.035	2700	0.80 ±0.15 (0.031 ±0.006)	4,000
BKP1608HS181TK	180	100	0.075	1500	0.80 ±0.15 (0.031 ±0.006)	4,000
BKP1608HS271TK	270	100	0.110	1200	0.80 ±0.15 (0.031 ±0.006)	4,000
BKP1608HS391TK	390	100	0.140	1000	0.80 ±0.15 (0.031 ±0.006)	4,000



### 0805 Multilayer Ferrite Chip Beads Standard Type (BK Series)

Ordering Code	Impedance (Ω) ±25%	Measuring Frequency (MHz)	Maximum DC Resistance (Ω)	Maximum Rated Current (mA)	Thickness mm (inches)	Tape & Reel Packaging Quantity
BK-2125HS150TK	15	100	0.05	1200	0.85 ±0.2 (0.033 ±0.008)	4,000
BK-2125HS220TK	22	100	0.05	1200	0.85 ±0.2 (0.033 ±0.008)	4,000
BK-2125HS330TK	33	100	0.05	1200	0.85 ±0.2 (0.033 ±0.008)	4,000
BK-2125HS470TK	47	100	0.05	1000	0.85 ±0.2 (0.033 ±0.008)	4,000
BK-2125HS750TK	75	100	0.10	1000	0.85 ±0.2 (0.033 ±0.008)	4,000
BK-2125HS101TK	100	100	0.10	900	0.85 ±0.2 (0.033 ±0.008)	4,000
BK-2125HS121TK	120	100	0.15	800	0.85 ±0.2 (0.033 ±0.008)	4,000
BK-2125HS241TK	240	100	0.20	600	0.85 ±0.2 (0.033 ±0.008)	4,000
BK-2125HS431TK	430	100	0.25	500	0.85 ±0.2 (0.033 ±0.008)	4,000
BK-2125HS601TK	600	100	0.30	500	0.85 ±0.2 (0.033 ±0.008)	4,000
BK-2125HS102TK	1000	100	0.40	300	0.85 ±0.2 (0.033 ±0.008)	4,000
BK-2125HM121TK	120	100	0.15	800	0.85 ±0.2 (0.033 ±0.008)	4,000
BK-2125HM241TK	240	100	0.20	600	0.85 ±0.2 (0.033 ±0.008)	4,000
BK-2125HM471TK	470	100	0.25	500	0.85 ±0.2 (0.033 ±0.008)	4,000
BK-2125HM601TK	600	100	0.25	500	0.85 ±0.2 (0.033 ±0.008)	4,000
BK-2125HM102TK	1000	100	0.35	400	0.85 ±0.2 (0.033 ±0.008)	4,000
BK-2125LL560TK	56	100	0.20	600	0.85 ±0.2 (0.033 ±0.008)	4,000
BK-2125LL121TK	120	100	0.30	400	0.85 ±0.2 (0.033 ±0.008)	4,000
BK-2125LL241TK	240	100	0.35	300	0.85 ±0.2 (0.033 ±0.008)	4,000
BK-2125LM751TK	750	100	0.30	400	0.85 ±0.2 (0.033 ±0.008)	4,000
BK-2125LM152TK	1500	100	0.35	400	0.85 ±0.2 (0.033 ±0.008)	4,000
BK-2125LM182TK	1800	100	0.45	300	1.25 ±0.2 (0.049 ±0.008)	2,000
BK-2125LM252TK	2500	100	0.75	200	1.25 ±0.2 (0.049 ±0.008)	2,000

### 0805 Multilayer Ferrite Chip Beads For Power Lines (BKP Series)

Ordering Code	Impedance (Ω) ±25%	Measuring Frequency (MHz)	Maximum DC Resistance (Ω)	Maximum Rated Current (mA)	Thickness mm (inches)	Tape & Reel Packaging Quantity
BKP2125HS330TK	33	100	0.020	4000	0.85 ±0.2 (0.033 ±0.008)	4,000
BKP2125HS600TK	60	100	0.025	3000	0.85 ±0.2 (0.033 ±0.008)	4,000
BKP2125HS101TK	100	100	0.040	2500	0.85 ±0.2 (0.033 ±0.008)	4,000
BKP2125HS221TK	220	100	0.050	2000	0.85 ±0.2 (0.033 ±0.008)	4,000

**DISCLAIMER**

All electronic components or devices listed in this catalog are developed, designed and intended for use in general electronic equipment. Before incorporating these components into any equipment in the fields of aerospace, military or medical, where higher safety and reliability are required, please contact KEMET Corp for more details.

# Double the possibilities.



**KEMET**  
CHARGED™

**TAIYO YUDEN**

Through our Strategic Alliance, announced in September of 2005, Taiyo Yuden and KEMET are working together to utilize best practices in the areas of manufacturing, technology, marketing, and customer support to better serve the electronics industry.

**World Sales Headquarters**

KEMET Electronics Corporation  
P.O. Box 5928  
Greenville, SC 29606  
Phone: 864-963-6300

**Europe**

KEMET Electronics S.A.  
1-3, Avenue de la Paix  
P.O.B. 76  
CH-1211 Geneva 20,  
Switzerland  
Phone: 41-22-715-0100

**Asia**

KEMET Electronics Marketing PTE Ltd.  
101 Thomson Road, #23-03  
United Square  
Singapore, 307591, Singapore  
Phone: 65-6353-6636

KEMET Electronics Asia Ltd.  
30 Canton Road, Room 1512  
SilverCord Tower II  
Tsimshatshui, Kowloon  
Hong Kong  
Phone: 852-2305-1168